



Republic of the Philippines  
**CITY GOVERNMENT OF SAN CARLOS**  
Province of Negros Occidental

**BIDS AND AWARDS COMMITTEE  
(BAC)**

**BIDDING DOCUMENTS**

**FOR**

**Purchase Request No. 221-24-10-1987**  
**Approved Budget of the Contract (ABC): ₱ 3,362,200.00**

**Contract Name:**

**CONSTRUCTION OF HOME ECONOMICS BUILDING AT BAIRAN ELEMENTARY  
SCHOOL BRGY. BULUANGAN, SAN CARLOS CITY, NEGROS OCCIDENTAL**

**With Terms of Reference (TOR) and Project Plan**

**(First Envelope: Eligibility and Technical Components)**

SUBMITTED BY : \_\_\_\_\_  
ADDRESS : \_\_\_\_\_  
CONTACT NO. : \_\_\_\_\_  
EMAIL AD : \_\_\_\_\_

\_\_\_\_\_  
DATE OF SUBMISSION

## INSTRUCTIONS TO BIDDERS

1. Please submit sets of documents completely in two separate envelopes:  
The First Envelope (Original, Copy 1 and Copy 2) containing Eligibility & Technical Documents  
The Second Envelope (Original, Copy 1 and Copy 2) containing Financial Documents.
2. Check that all annexes are in accordance with the prescribed format and submit it in chronological order.
3. Submit your completed bid documents on or before the time of the opening of bids mentioned below.
4. Electronic submission and receipt of bids is not available pending compliance with GPPB Resolutions.

Compliance of the above is for mutual advantage, i.e. to facilitate a complete and thorough evaluation of your bid documents.

### SCHEDULES

**Schedule/Place of Pre-bid Conference**

**Dec. 05, 2024 @ 8:30 AM**  
BAC Secretarial Office  
2F City Hall Building

**Schedule/Place of Bid Opening**

**Dec. 17, 2024 @ 1:30 PM**  
BAC Secretarial Office  
2F City Hall Building

**Nonrefundable fee of Bidding Documents @ Php 5,000.00**

**Bid and Awards Committee  
City of San Carlos**





**Republic of the Philippines  
City Government of San Carlos  
Province of Negros Occidental**

**Contract Name: CONSTRUCTION OF HOME ECONOMICS BUILDING AT BAIRAN  
ELEMENTARY SCHOOL BRGY. BULUANGAN**

**Location of the Contract: San Carlos City, Negros Occidental**

---

- 1. PHILGEPS (Certificate Of Registration And Membership in accordance with Section 8.5.2 Of R.A 9184 - Platinum Membership)**

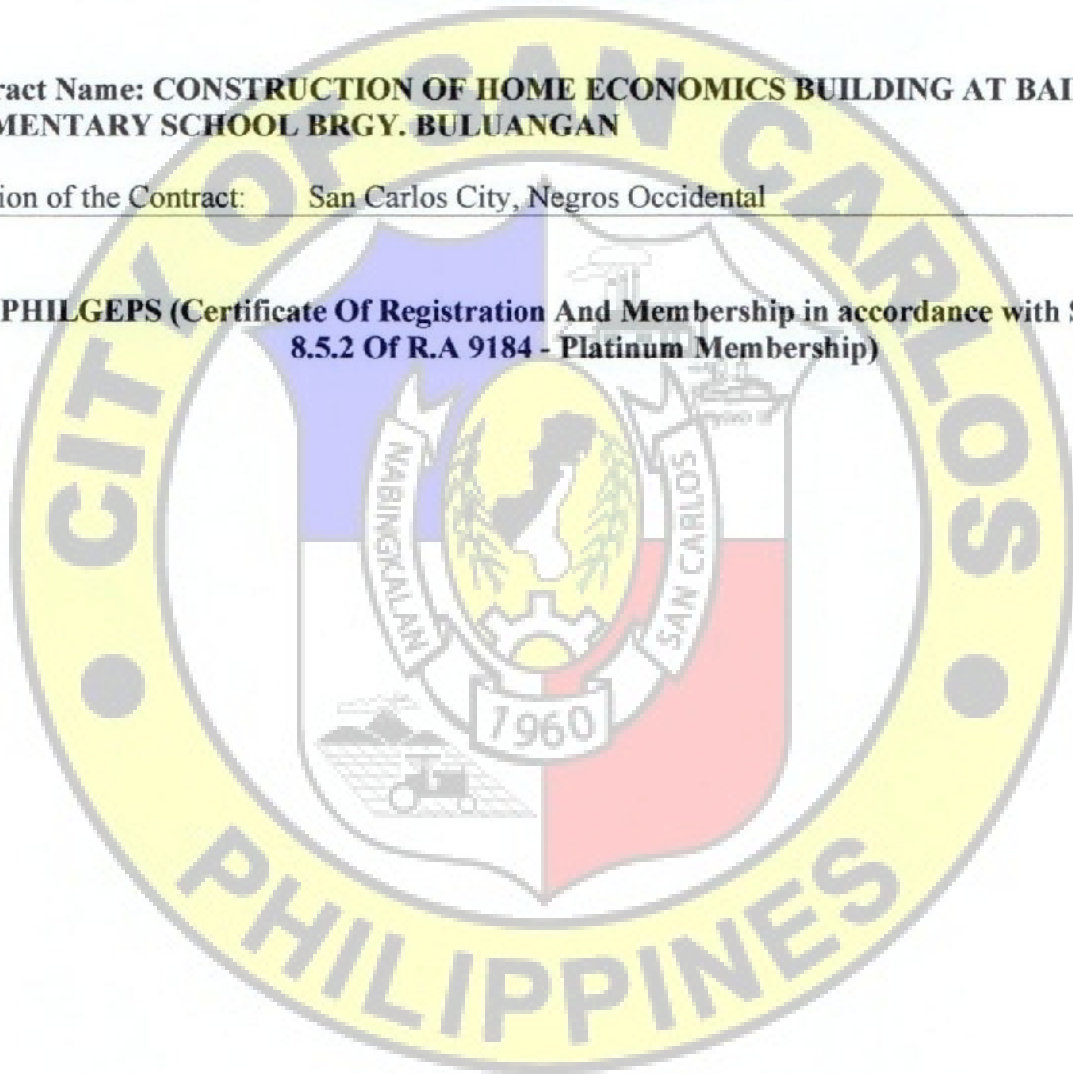

Republic of the Philippines  
City Government of San Carlos  
Province of Negros Occidental

**Contract Name: CONSTRUCTION OF HOME ECONOMICS BUILDING AT BAIRAN  
ELEMENTARY SCHOOL BRGY. BULUANGAN**

Location of the Contract: San Carlos City, Negros Occidental

**2. JOINT VENTURE AGREEMENT (JVA), IF APPLICABLE**

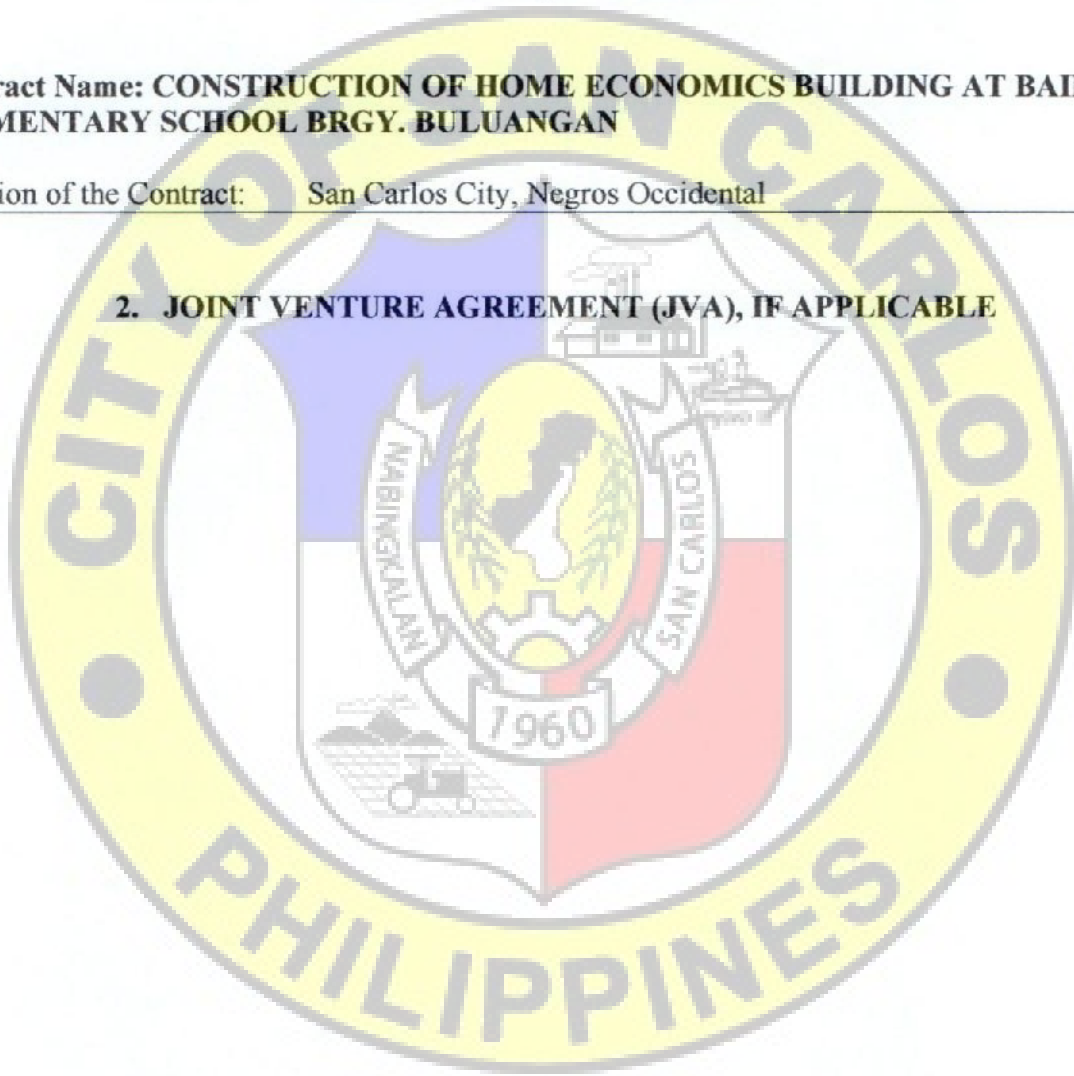

**Republic of the Philippines  
City Government of San Carlos  
Province of Negros Occidental**

**Contract Name: CONSTRUCTION OF HOME ECONOMICS BUILDING AT BAIRAN  
ELEMENTARY SCHOOL BRGY. BULUANGAN**

**Location of the Contract: San Carlos City, Negros Occidental**

---

- 3. NFCC BASED ON THE DATA SUBMITTED TO THE BIR THRU ITS EFPS  
OR COMMITTED LINE OF CREDIT (CLC) FROM A UNIVERSAL OR  
COMMERCIAL BANK**

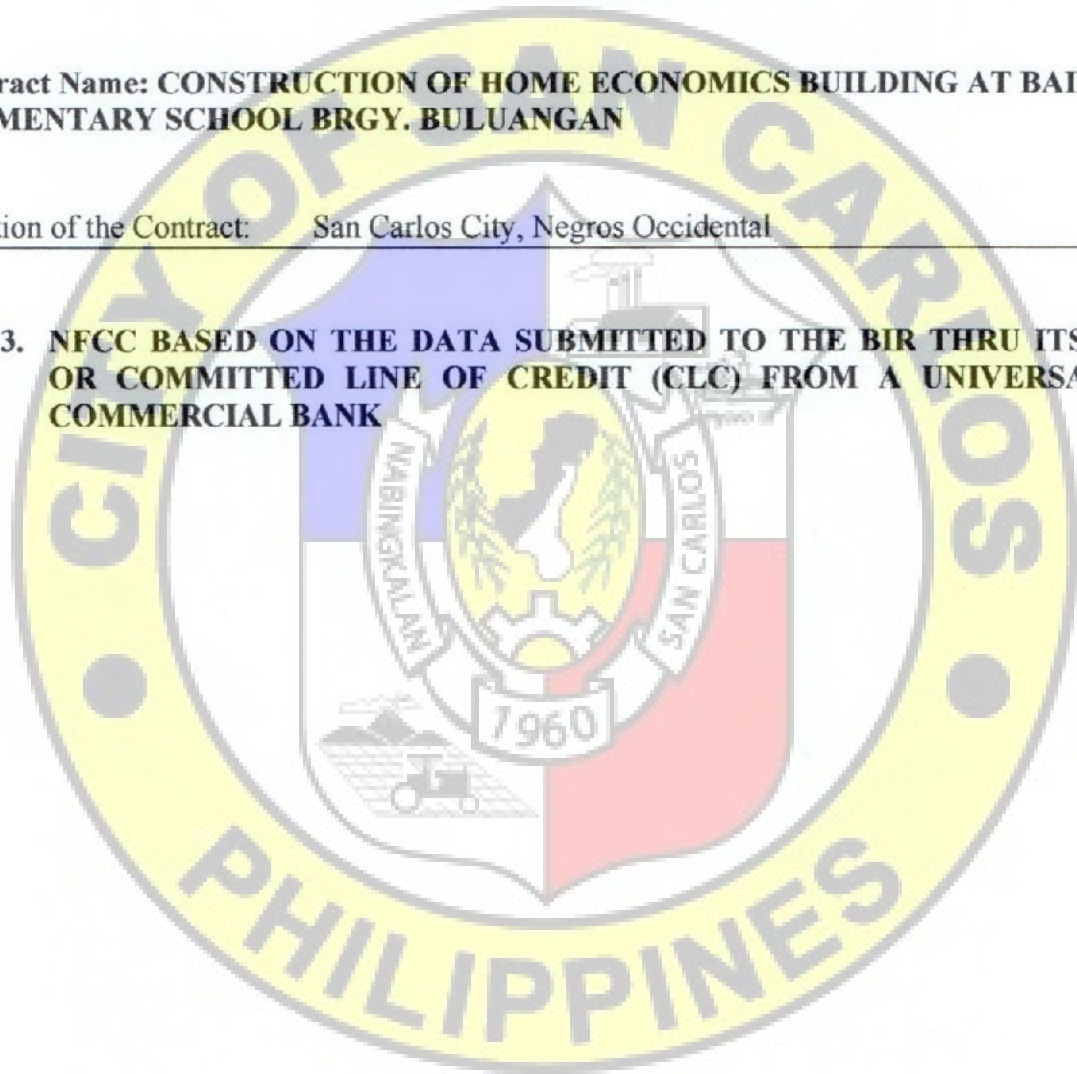

**Republic of the Philippines  
City Government of San Carlos  
Province of Negros Occidental**

**Contract Name: CONSTRUCTION OF HOME ECONOMICS BUILDING AT BAIRAN  
ELEMENTARY SCHOOL BRGY. BULUANGAN**

Location of the Contract: San Carlos City, Negros Occidental

**4. DULY NOTARIZED STATEMENT OF ALL ON-GOING GOVERNMENT AND  
PRIVATE CONTRACTS**

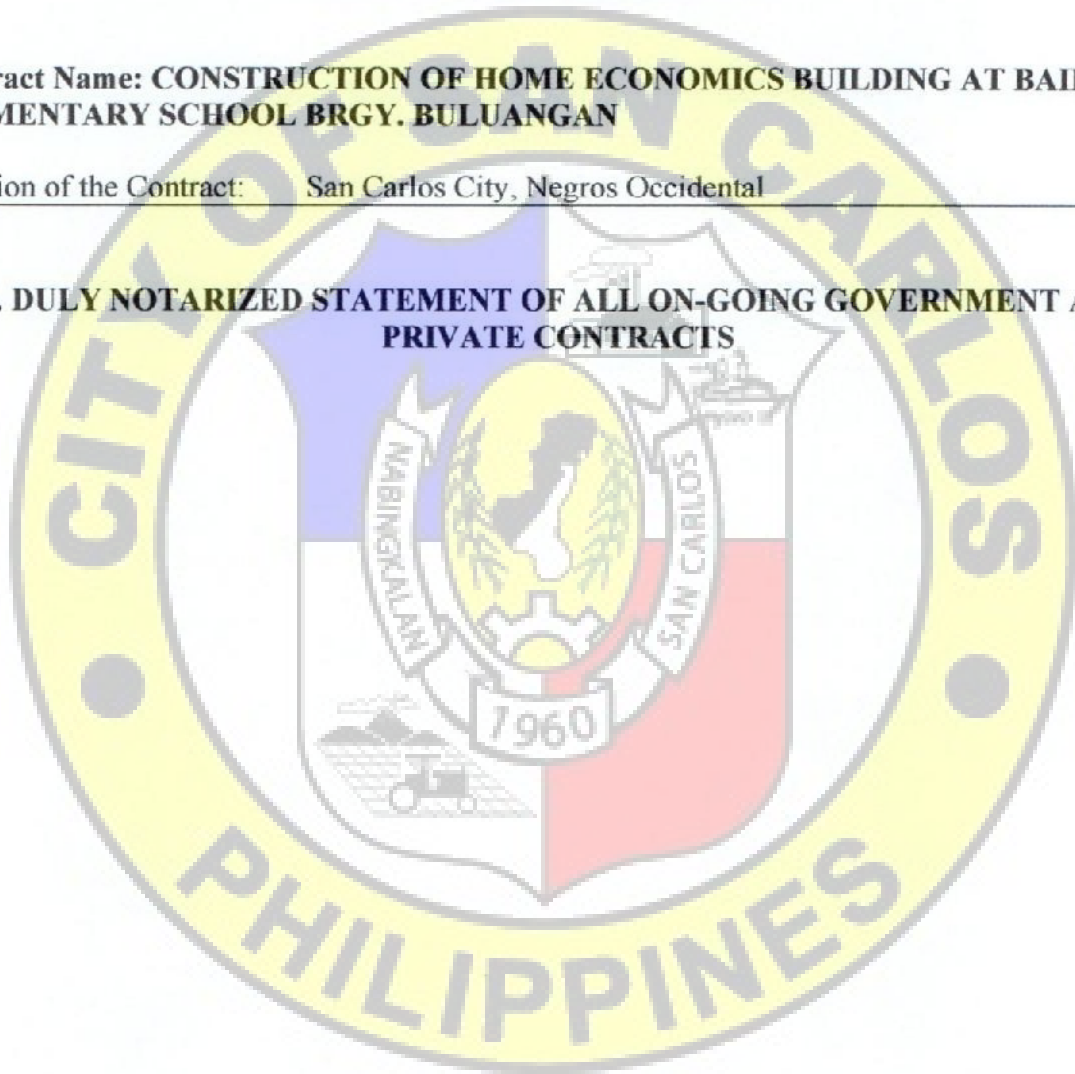

**Republic of the Philippines  
City Government of San Carlos  
Province of Negros Occidental**

**Contract Name: CONSTRUCTION OF HOME ECONOMICS BUILDING AT BAIRAN  
ELEMENTARY SCHOOL BRGY. BULUANGAN**

**Location of the Contract: San Carlos City, Negros Occidental**

---

**5. DULY NOTARIZED STATEMENT OF:**

- A. At least three (3) Completed Similar Contracts (Government or Private) for the last five (5) years.**
- B. Single Largest Completed Contract (SLCC) at least 50% of the total ABC.**

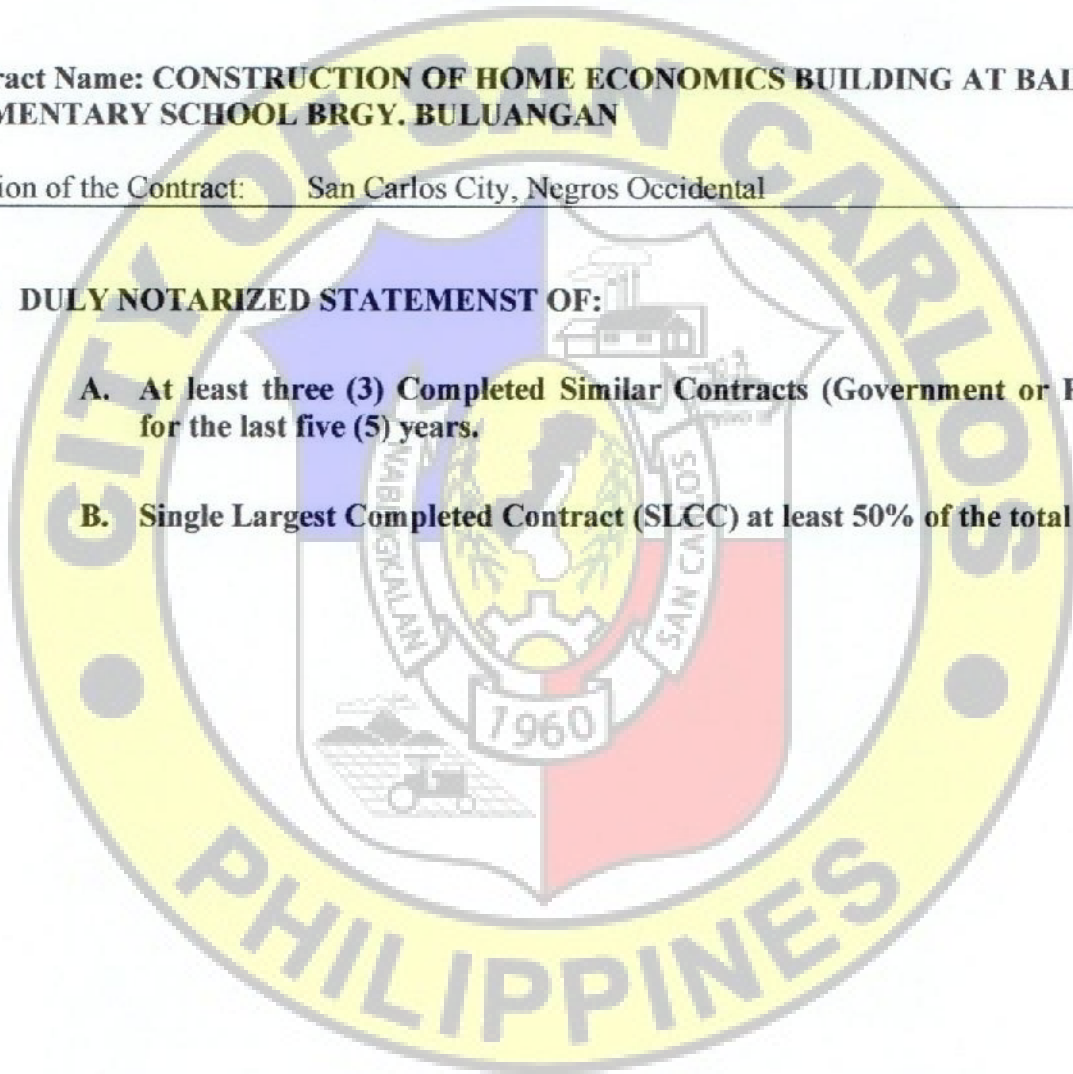



**Republic of the Philippines  
City Government of San Carlos  
Province of Negros Occidental**

**Contract Name: CONSTRUCTION OF HOME ECONOMICS BUILDING AT BAIRAN  
ELEMENTARY SCHOOL BRGY. BULUANGAN**

Location of the Contract: San Carlos City, Negros Occidental

**6. PCAB LICENSE**

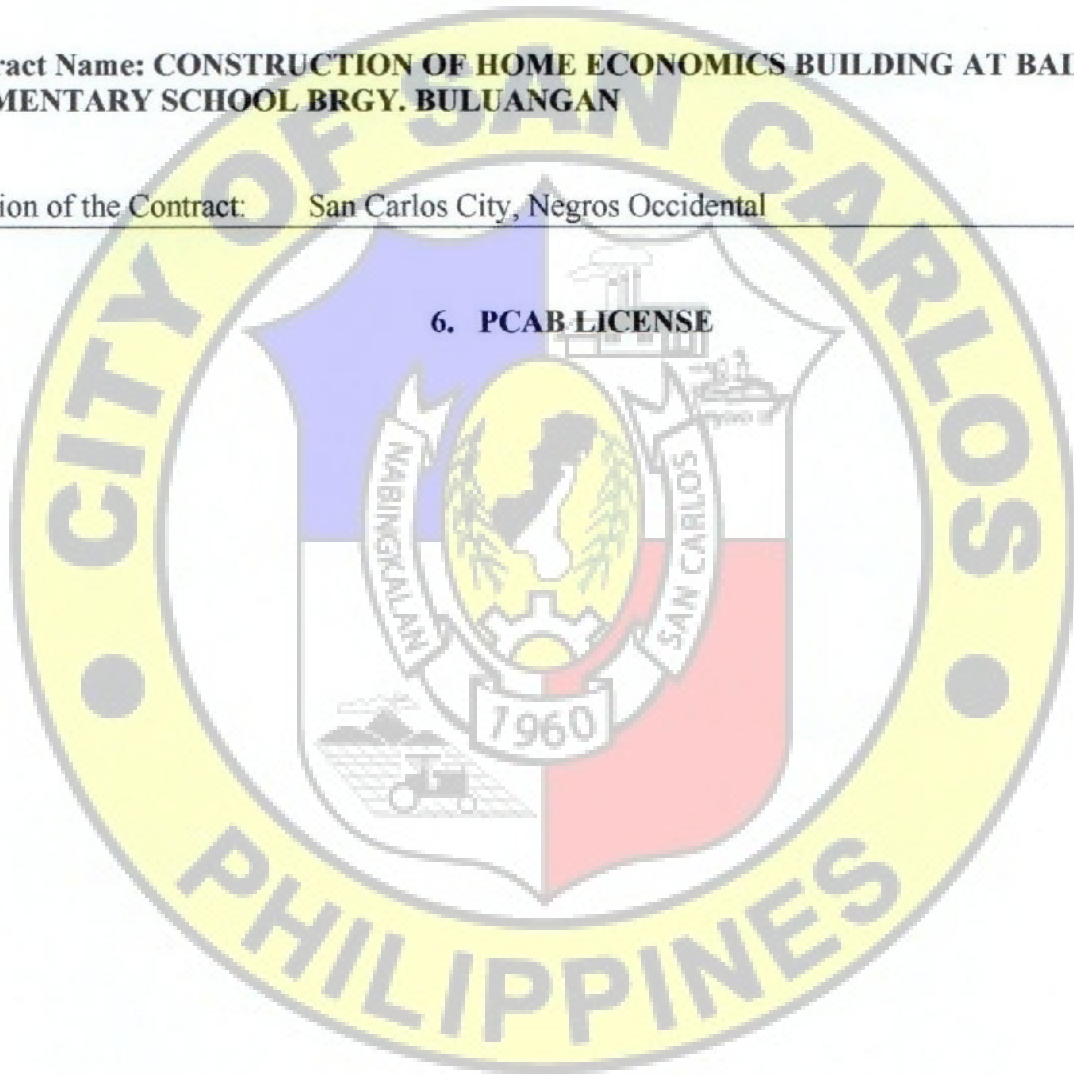

Republic of the Philippines  
City Government of San Carlos  
Province of Negros Occidental

Contract Name: CONSTRUCTION OF HOME ECONOMICS BUILDING AT BAIRAN  
ELEMENTARY SCHOOL BRGY. BULUANGAN

Location of the Contract: San Carlos City, Negros Occidental

7. PROJECT REQUIREMENTS:

- a. Organizational Chart for the contract to be bid
- b. List of Contractor's Personnel (Civil Engineer, Skilled laborers [to include Mason, Welder, and Carpenter], and Manual laborers) to be assigned to the contract to be bid with their complete qualification and experience data
- c. List of Contractor's Equipment (owned, leased and/or under purchase agreements, supported by certification of availability of equipment from the equipment lessor/vendor for the duration of the project)
- d. Duly Notarized Affidavit of Site Inspection (Please see attached Form)

Name of the Procuring Entity

Contract Reference Number  
Name of the Contract  
Location of the Contract

Standard Form Number: SF-INFR-51  
Revised on: August 11, 2004

**AFFIDAVIT OF SITE INSPECTION**

I, \_\_\_\_\_ (Representative of the Bidder), of legal age, \_\_\_\_\_ civil status, Filipino and residing

at \_\_\_\_\_ (Address of the Representative), under oath, hereby depose and say:

That I am the \_\_\_\_\_ (Position in the Bidder) of the \_\_\_\_\_ (Name of the Bidder), with office at \_\_\_\_\_ (Address of the Bidder);

That I have inspected the site for \_\_\_\_\_ (Name of the Contract), located at \_\_\_\_\_ (Location of the Contract);

That I am making this statement as part of the requirement for the Technical Proposal of the \_\_\_\_\_ (Name of the Bidder) for \_\_\_\_\_ (Name of the Contract).

IN FAITH WHEREOF, I hereby affix my signature this \_\_\_\_\_ day of \_\_\_\_\_, 20\_\_\_\_ at \_\_\_\_\_, Philippines.

SUBSCRIBED AND SWORN TO before me this \_\_\_\_\_ day of \_\_\_\_\_, 20\_\_\_\_, affiant \_\_\_\_\_ AFFIANT

Exhibiting to me his/her Community Tax Certificate No. \_\_\_\_\_ issued on \_\_\_\_\_ at \_\_\_\_\_, Philippines.

Public)

\_\_\_\_\_  
(Notary

Until

\_\_\_\_\_  
PTR No.

\_\_\_\_\_  
Date

\_\_\_\_\_  
Place

\_\_\_\_\_  
TIN

Document No. \_\_\_\_\_  
Page No. \_\_\_\_\_  
Book No. \_\_\_\_\_  
Series of \_\_\_\_\_



Republic of the Philippines  
City Government of San Carlos  
Province of Negros Occidental

Contract Name: CONSTRUCTION OF HOME ECONOMICS BUILDING AT BAIRAN  
ELEMENTARY SCHOOL BRGY. BULUANGAN

Location of the Contract: San Carlos City, Negros Occidental

**8. BID SECURITY IN ANY OF THE FOLLOWING FORMS:**

- a) Cash or cashier's / Manager's Check issued by a Universal or Commercial Bank in favor of the City Treasurer of San Carlos City. :Two percent (2%) of the ABC
- b) Bank draft/guarantee or irrevocable letter of credit issued by a Universal or Commercial Bank. Provided, however, that it shall be confirmed or authenticated by a Universal or Commercial Bank. :Two percent (2%) of the ABC
- c) Surety Bond callable upon demand issued by a surety or insurance company duly certified by the Insurance Commission as authorized to issue such security. :Fiver percent (5%) of the ABC
- d) Any combination of the foregoing :Proportionate to share form with respect to total amount of security
- e) Bid Securing Declaration

REPUBLIC OF THE PHILIPPINES  
CITY OF SAN CARLOS, NEGROS OCCIDENTAL) S.S.

**BID SECURING DECLARATION**

Project Identification No. / Purchase Request (PR) No. : 221-24-10-1987

To: *[Insert name and address of the Procuring Entity]*

I/We, the undersigned, declare that:

- I/We understand that, according to your conditions, bids must be supported by a Bid Security, which may be in the form of a Bid Securing Declaration.
- I/We accept that: (a) I/we will be automatically disqualified from bidding for any procurement contract with any procuring entity for a period of two (2) years upon receipt of your Blacklisting Order; and, (b) I/we will pay the applicable fine provided under Section 6 of the Guidelines on the Use of Bid Securing Declaration, within fifteen (15) days from receipt of the written demand by the procuring entity for the commission of acts resulting to the enforcement of the bid securing declaration under Sections 23.1(b), 34.2, 40.1 and 69.1, except 69.1(f), of the IRR of RA No. 9184; without prejudice to other legal action the government may undertake.
- I/We understand that this Bid Securing Declaration shall cease to be valid on the following circumstances:
  - Upon expiration of the bid validity period, or any extension thereof pursuant to your request;
  - I am/we are declared ineligible or post-disqualified upon receipt of your notice to such effect, and (i) I/we failed to timely file a request for reconsideration or (ii) I/we filed a waiver to avail of said right; and
  - I am/we are declared the bidder with the Lowest Calculated Responsive Bid, and I/we have furnished the performance security and signed the Contract.

IN WITNESS WHEREOF, I/We have hereunto set my/our hand/s this \_\_\_\_ day of *[month]* *[year]* at *[place of execution]*.

*[Insert NAME OF BIDDER OR ITS AUTHORIZED REPRESENTATIVE]*

*[Insert signatory's legal capacity]*

Affiant

[Jurat]

[Format shall be based on the latest Rules on Notarial Practice]



Republic of the Philippines  
City Government of San Carlos  
Province of Negros Occidental

Contract Name: CONSTRUCTION OF HOME ECONOMICS BUILDING AT BAIRAN  
ELEMENTARY SCHOOL BRGY. BULUANGAN

Location of the Contract: San Carlos City, Negros Occidental

9. OMNIBUS SWORN STATEMENT IN ACCORDANCE WITH SECTION 25.3

for

Purchase Request (PR) No. 221-24-10-1987

REPUBLIC OF THE PHILIPPINES)

CITY OF SAN CARLOS, NEGROS OCCIDENTAL) S.S

**AFFIDAVIT**

I, [Name of Affiant], of legal age, [Civil Status], [Nationality], and residing at [Address of Affiant], after having been duly sworn in accordance with law, do hereby depose and state that:

1. *[Select one, delete the other:]*

*[If a sole proprietorship:]* I am the sole proprietor or authorized representative of [Name of Bidder] with office address at [address of Bidder];

*[If a partnership, corporation, cooperative, or joint venture:]* I am the duly authorized and designated representative of [Name of Bidder] with office address at [address of Bidder];

2. *[Select one, delete the other:]*

*[If a sole proprietorship:]* As the owner and sole proprietor, or authorized representative of [Name of Bidder], I have full power and authority to do, execute and perform any and all acts necessary to participate, submit the bid, and to sign and execute the ensuing contract for [Name of the Project] of the [Name of the Procuring Entity], as shown in the attached duly notarized Special Power of Attorney;

*[If a partnership, corporation, cooperative, or joint venture:]* I am granted full power and authority to do, execute and perform any and all acts necessary to participate, submit the bid, and to sign and execute the ensuing contract for [Name of the Project] of the [Name of the Procuring Entity], as shown in the attached [state title of attached document showing proof of authorization (e.g., duly notarized Secretary's Certificate, Board/Partnership Resolution, or Special Power of Attorney, whichever is applicable)];

3. [Name of Bidder] is not "blacklisted" or barred from bidding by the Government of the Philippines or any of its agencies, offices, corporations, or Local Government Units, foreign government/foreign or international financing institution whose blacklisting rules have been recognized by the Government Procurement Policy Board, **by itself or by relation, membership, association, affiliation, or controlling interest with another blacklisted person or entity as defined and provided for in the Uniform Guidelines on Blacklisting;**

4. Each of the documents submitted in satisfaction of the bidding requirements is an authentic copy of the original, complete, and all statements and information provided therein are true and correct;

5. [Name of Bidder] is authorizing the Head of the Procuring Entity or its duly authorized representative(s) to verify all the documents submitted;



6. *[Select one, delete the rest:]*

*[If a sole proprietorship:]* The owner or sole proprietor is not related to the Head of the Procuring Entity, members of the Bids and Awards Committee (BAC), the Technical Working Group, and the BAC Secretariat, the head of the Project Management Office or the end-user unit, and the project consultants by consanguinity or affinity up to the third civil degree;

*[If a partnership or cooperative:]* None of the officers and members of *[Name of Bidder]* is related to the Head of the Procuring Entity, members of the Bids and Awards Committee (BAC), the Technical Working Group, and the BAC Secretariat, the head of the Project Management Office or the end-user unit, and the project consultants by consanguinity or affinity up to the third civil degree;

*[If a corporation or joint venture:]* None of the officers, directors, and controlling stockholders of *[Name of Bidder]* is related to the Head of the Procuring Entity, members of the Bids and Awards Committee (BAC), the Technical Working Group, and the BAC Secretariat, the head of the Project Management Office or the end-user unit, and the project consultants by consanguinity or affinity up to the third civil degree;

7. *[Name of Bidder]* complies with existing labor laws and standards; and

8. *[Name of Bidder]* is aware of and has undertaken the responsibilities as a Bidder in compliance with the Philippine Bidding Documents, which includes:

- a. Carefully examining all of the Bidding Documents;
- b. Acknowledging all conditions, local or otherwise, affecting the implementation of the Contract;
- c. Making an estimate of the facilities available and needed for the contract to be bid, if any; and
- d. Inquiring or securing Supplemental/Bid Bulletin(s) issued for the *[Name of the Project]*.

9. *[Name of Bidder]* did not give or pay directly or indirectly, any commission, amount, fee, or any form of consideration, pecuniary or otherwise, to any person or official, personnel or representative of the government in relation to any procurement project or activity.

10. **In case advance payment was made or given, failure to perform or deliver any of the obligations and undertakings in the contract shall be sufficient grounds to constitute criminal liability for Swindling (Estafa) or the commission of fraud with unfaithfulness or abuse of confidence through misappropriating or converting any payment received by a person or entity under an obligation involving the duty to deliver certain goods or services, to the prejudice of the public and the government of the Philippines pursuant to Article 315 of Act No. 3815 s. 1930, as amended, or the Revised Penal Code.**

IN WITNESS WHEREOF, I have hereunto set my hand this \_\_\_ day of \_\_\_, 20\_\_ at \_\_\_\_\_, Philippines.

*[Insert NAME OF BIDDER OR ITS AUTHORIZED REPRESENTATIVE]*

*[Insert signatory's legal capacity]*

Affiant

**[Jurat]**

*[Format shall be based on the latest Rules on Notarial Practice]*



Republic of the Philippines  
**CITY GOVERNMENT OF SAN CARLOS**  
Province of Negros Occidental

**BIDS AND AWARDS COMMITTEE  
(BAC)**

**BIDDING DOCUMENTS**

**FOR**

**Purchase Request No. 221-24-10-1987  
Approved Budget of the Contract (ABC): ₱ 3,362,200.00**

**Contract Name:**

**CONSTRUCTION OF HOME ECONOMICS BUILDING AT BAIRAN ELEMENTARY  
SCHOOL BRGY. BULUANGAN, SAN CARLOS CITY, NEGROS OCCIDENTAL**

**With Terms of Reference (TOR) and Project Plan**

**(Second Envelope: Financial Component)**

SUBMITTED BY : \_\_\_\_\_  
ADDRESS : \_\_\_\_\_  
CONTACT NO. : \_\_\_\_\_  
EMAIL AD : \_\_\_\_\_

\_\_\_\_\_  
DATE OF SUBMISSION



## INSTRUCTIONS TO BIDDERS

1. Please submit sets of documents completely in two separate envelopes:  
The First Envelope (Original, Copy 1 and Copy 2) containing Eligibility & Technical Documents  
The Second Envelope (Original, Copy 1 and Copy 2) containing Financial Documents.
2. Check that all annexes are in accordance with the prescribed format and submit it in chronological order.
3. Submit your completed bid documents on or before the time of the opening of bids mentioned below.
4. Electronic submission and receipt of bids is not available pending compliance with GPPB Resolutions.

Compliance of the above is for mutual advantage, i.e. to facilitate a complete and thorough evaluation of your bid documents.

### SCHEDULES

**Schedule/Place of Pre-bid Conference**

**Dec. 05, 2024 @ 8:30 AM**  
BAC Secretarial Office  
2F City Hall Building

**Schedule/Place of Bid Opening**

**Dec. 17, 2024 @ 1:30 PM**  
BAC Secretarial Office  
2F City Hall Building

**Nonrefundable fee of Bidding Documents @ Php 5,000.00**

**Bid and Awards Committee  
City of San Carlos**

**Republic of the Philippines  
City Government of San Carlos  
Province of Negros Occidental**

**Contract Name: CONSTRUCTION OF HOME ECONOMICS BUILDING AT BAIRAN  
ELEMENTARY SCHOOL BRGY. BULUANGAN**

**Location of the Contract: San Carlos City, Negros Occidental**

---

**CHECKLIST OF FINANCIAL PROPOSALS/REQUIREMENTS**

1. Duly Signed Form of Bid
2. Duly Signed Bid Price in the Bill of Quantities
3. Duly Signed Detailed Estimates
4. Duly Signed Cash flow by quarter and payment schedule

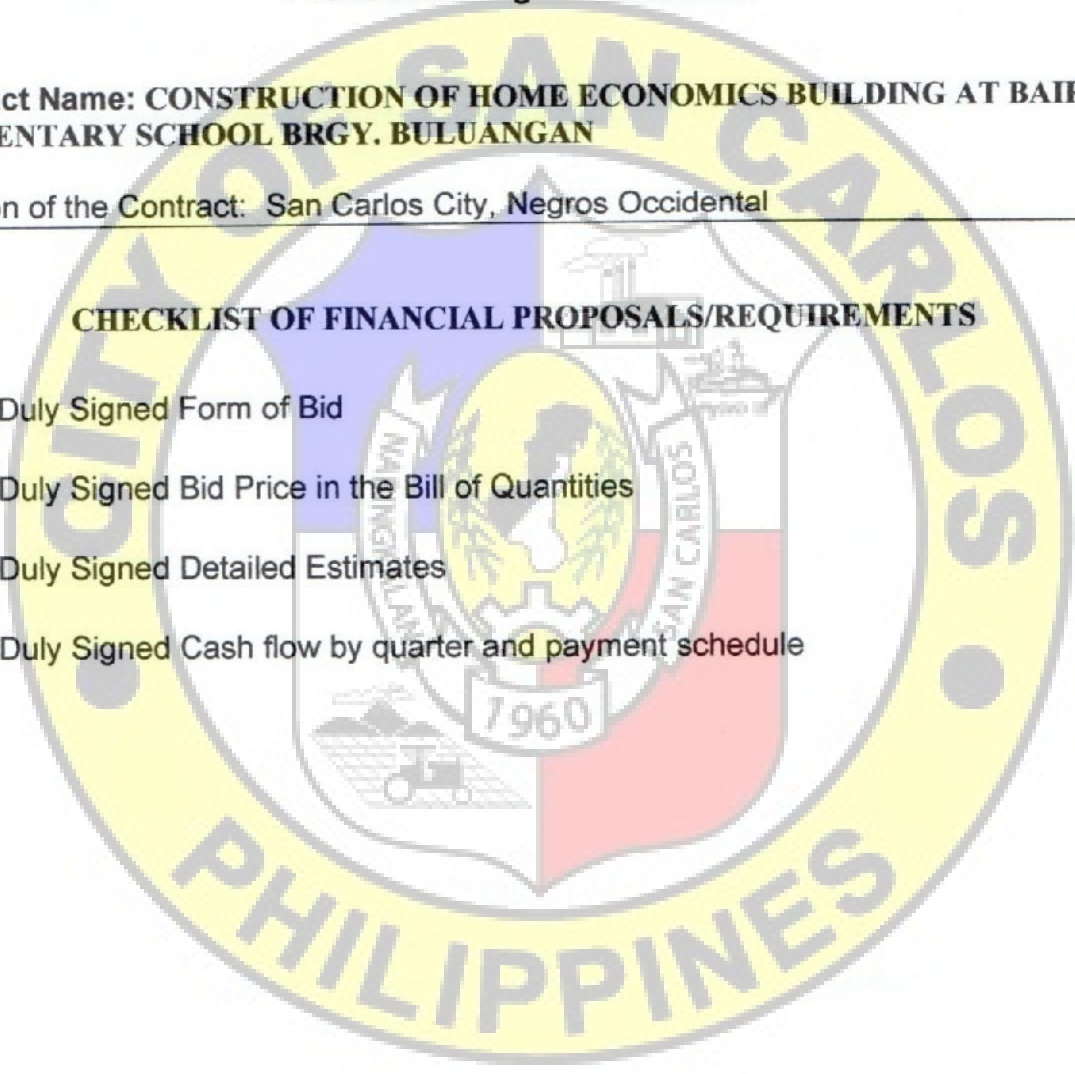



Republic of the Philippines  
City Government of San Carlos  
Province of Negros Occidental

**Contract Name: CONSTRUCTION OF HOME ECONOMICS BUILDING AT BAIRAN  
ELEMENTARY SCHOOL BRGY. BULUANGAN**

Location of the Contract: San Carlos City, Negros Occidental

**1. DULY SIGNED BID FORM**

Date : \_\_\_\_\_

Project Identification / Purchase Request No. : 221-24-10-1987

To: *[name and address of Procuring Entity]*

Having examined the Philippine Bidding Documents (PBDs) including the Supplemental or Bid Bulletin Numbers *[insert numbers]*, the receipt of which is hereby duly acknowledged, we, the undersigned, declare that:

- a. We have no reservation to the PBDs, including the Supplemental or Bid Bulletins, for the Procurement Project: *[insert name of contract]*;
- b. We offer to execute the Works for this Contract in accordance with the PBDs;
- c. The total price of our Bid in words and figures, excluding any discounts offered below is: *[insert information]*;
- d. The discounts offered and the methodology for their application are: *[insert information]*;
- e. The total bid price includes the cost of all taxes, such as, but not limited to: *[specify the applicable taxes, e.g. (i) value added tax (VAT), (ii) income tax, (iii) local taxes, and (iv) other fiscal levies and duties]*, which are itemized herein and reflected in the detailed estimates,
- f. Our Bid shall be valid within the a period stated in the PBDs, and it shall remain binding upon us at any time before the expiration of that period;
- g. If our Bid is accepted, we commit to obtain a Performance Security in the amount of *[insert percentage amount]* percent of the Contract Price for the due performance of the Contract, or a Performance Securing Declaration in lieu of the the allowable forms of Performance Security, subject to the terms and conditions of issued GPPB guidelines<sup>1</sup> for this purpose;
- h. We are not participating, as Bidders, in more than one Bid in this bidding process, other than alternative offers in accordance with the Bidding Documents;
- i. We understand that this Bid, together with your written acceptance thereof included in your notification of award, shall constitute a binding contract between us, until a formal Contract is prepared and executed; and
- j. We understand that you are not bound to accept the Lowest Calculated Bid or any other Bid that you may receive.
- k. We likewise certify/confirm that the undersigned, is the duly authorized representative of the bidder, and granted full power and authority to do, execute and perform any and all acts necessary to participate, submit the bid, and to sign and execute the ensuing contract for the *[Name of Project]* of the *[Name of the Procuring Entity]*.
- l. We acknowledge that failure to sign each and every page of this Bid Form, including the Bill of Quantities, shall be a ground for the rejection of our bid.

Name: \_\_\_\_\_

Legal Capacity: \_\_\_\_\_

Signature: \_\_\_\_\_

Duly authorized to sign the Bid for and behalf of: \_\_\_\_\_

Date: \_\_\_\_\_

\_\_\_\_\_



**Republic of the Philippines  
City Government of San Carlos  
Province of Negros Occidental**

**Contract Name: CONSTRUCTION OF HOME ECONOMICS BUILDING AT BAIRAN  
ELEMENTARY SCHOOL BRGY. BULUANGAN**

**Location of the Contract: San Carlos City, Negros Occidental**

<b>2. DULY SIGNED BID PRICE IN THE BILL OF QUANTITIES</b>					
<small>(Columns (1), (2) and (3) are to be filled up by the Procuring Entity)</small>			<small>(Columns (4) and (5) are to be filled up by the Bidder)</small>		
	<b>DESCRIPTION</b>	<b>UNIT</b>	<b>QTY</b>	<b>UNIT PRICE (PESOS)</b>	<b>AMOUNT (PESOS)</b>
	(1)	(2)	(3)	(4)	(5)
I	Mobilization	Lot	1.0	In words: Pesos _____ In figures: PHP	In words: Pesos _____ In figures: PHP
II	Concrete and Masonry Works	Sq.m.	90.0	In words: Pesos _____ In figures: PHP	In words: Pesos _____ In figures: PHP
III	Roofing Framing and Roofing Works	Sq.m.	192.0	In words: Pesos _____ In figures: PHP	In words: Pesos _____ In figures: PHP
IV	Ceiling Works	Sq.m.	144.0	In words: Pesos _____ In figures: PHP	In words: Pesos _____ In figures: PHP
V	Tile Works	Sq.m.	90.0	In words: Pesos _____ In figures: PHP	In words: Pesos _____ In figures: PHP
VI	Painting Works	Sq.m.	144.0	In words: Pesos _____ In figures: PHP	In words: Pesos _____ In figures: PHP
VII	Doors and Windows	lot	1.0	In words: Pesos _____ In figures: PHP	In words: Pesos _____ In figures: PHP
VIII	Plumbing Works	Sq.m.	1.0	In words: Pesos _____ In figures: PHP	In words: Pesos _____ In figures: PHP
IX	Electrical Works	Sq.m.	1.0	In words: Pesos _____ In figures: PHP	In words: Pesos _____ In figures: PHP
X	Demobilization	Lot	1.0	In words: Pesos _____ In figures: PHP	In words: Pesos _____ In figures: PHP
<b>TOTAL BID COST</b>					In words: Pesos _____ In figures: PHP
					In figures: PHP _____

Submitted by:

\_\_\_\_\_  
Name of the Representative of the Bidder

\_\_\_\_\_  
Position

\_\_\_\_\_  
Name of the Bidder Company

Date: \_\_\_\_\_

Republic of the Philippines  
City Government of San Carlos  
Province of Negros Occidental

**Contract Name: CONSTRUCTION OF HOME ECONOMICS BUILDING AT BAIRAN  
ELEMENTARY SCHOOL BRGY. BULUANGAN**

Location of the Contract: San Carlos City, Negros Occidental

**3. DULY SIGNED DETAILED ESTIMATES**

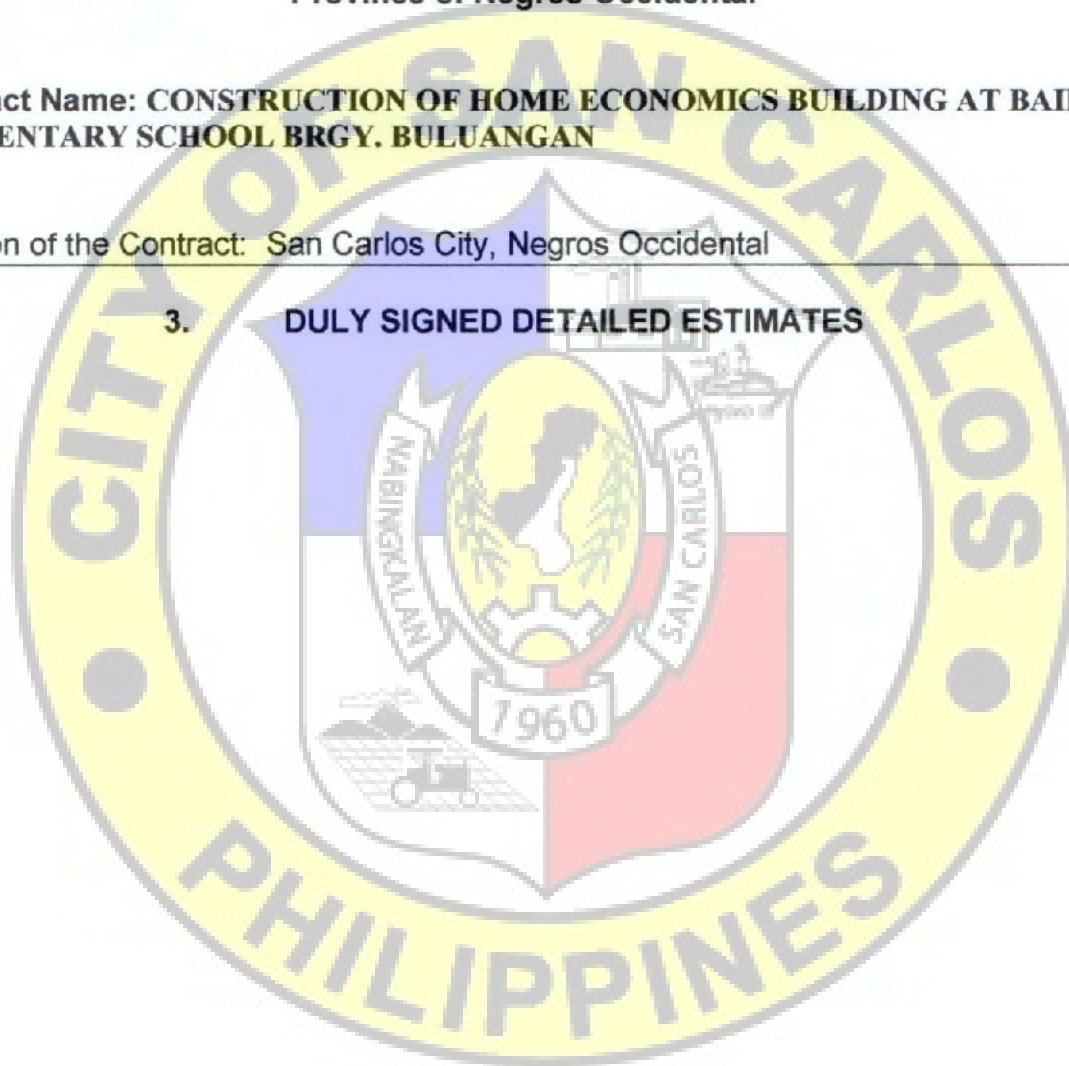

Republic of the Philippines  
City Government of San Carlos  
Province of Negros Occidental

**Contract Name: CONSTRUCTION OF HOME ECONOMICS BUILDING AT BAIRAN  
ELEMENTARY SCHOOL BRGY. BULUANGAN**

Location of the Contract: San Carlos City, Negros Occidental

**4. DULY SIGNED CASH FLOW BY QUARTER AND PAYMENT SCHEDULE**

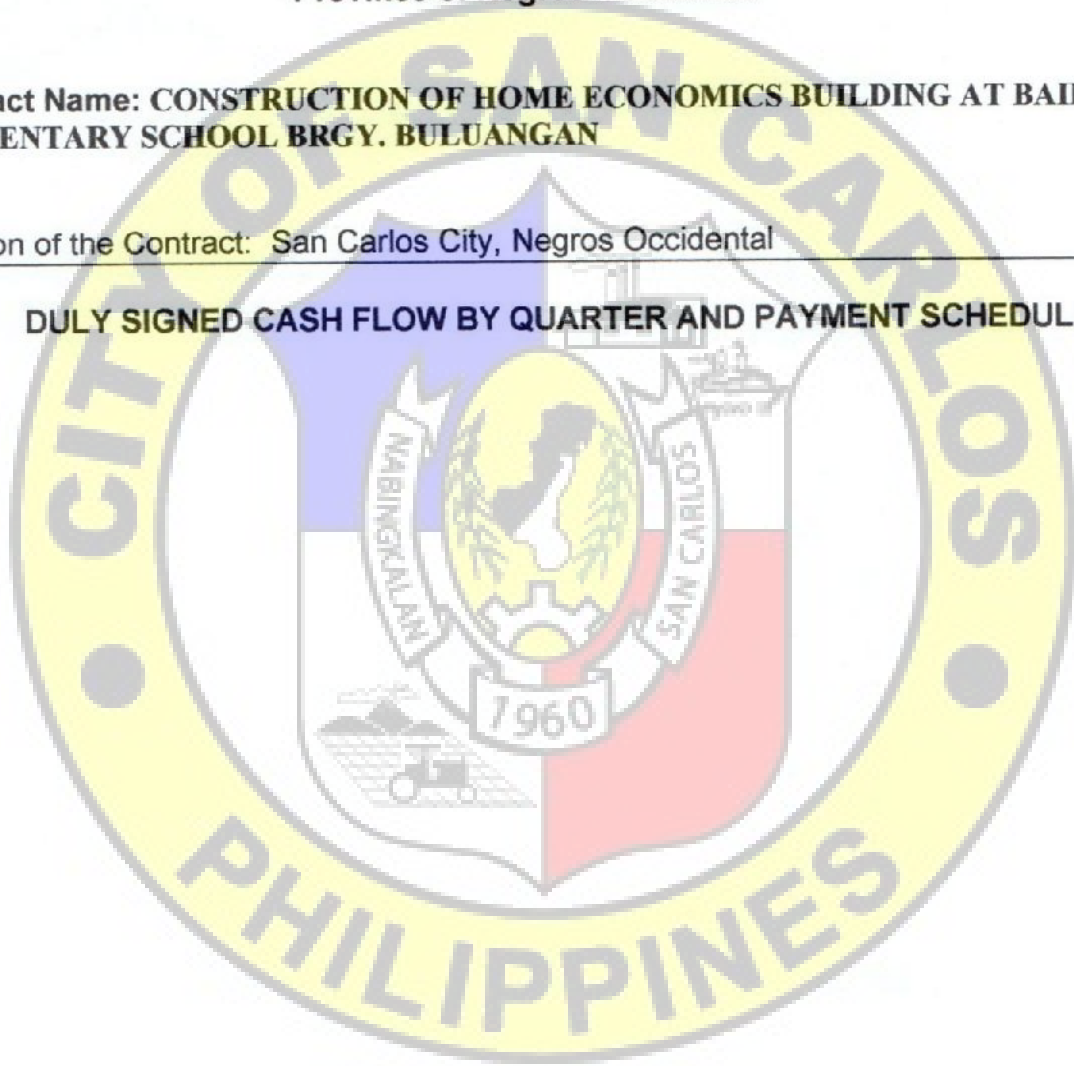



APPROVAL PAGE

CONSTRUCTION OF HOME ECONOMICS BUILDING AT BAIRAN  
ELEMENTARY SCHOOL BRGY. BULUANGAN

(P 3,362,200.00)

TERMS OF REFERENCE

City of San Carlos  
Province of Negros Occidental

Prepared by:

**John Leur C. Virtucio**

Engineer I

Reviewed by:

**Rexter E. Nemenzo**

CGDI-1 (City Engineer)

Approved by:

**Benato Y. Gustilo**

City Mayor

Republic of the Philippines

City of San Carlos

Province of Negros Occidental

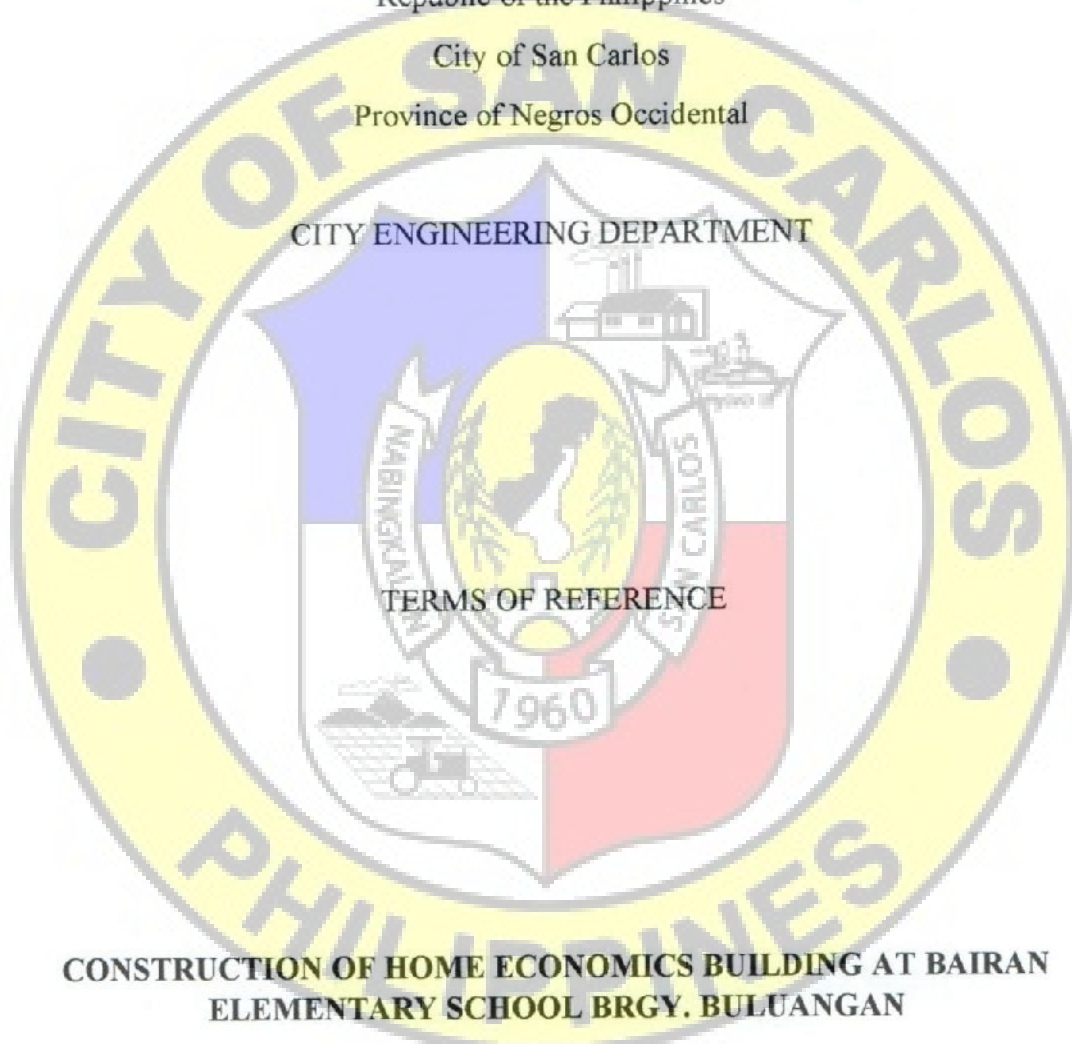

CITY ENGINEERING DEPARTMENT

TERMS OF REFERENCE

**CONSTRUCTION OF HOME ECONOMICS BUILDING AT BAIRAN  
ELEMENTARY SCHOOL BRGY. BULUANGAN**

**(P 3,362,200.00)**

*[Handwritten signatures]*

TABLE OF CONTENTS

A. Background	4
B. General Objective	4
C. The Bidder/Contractor	4
D. The Requirements	4
E. Delivery/Completion	8
F. Manpower Requirement	8
G. Warranty	8
H. Payment Scheme	8



*[Handwritten signatures]*

## A. Background

A number of Public Schools situated in the remote rural Barangays in the City of San Carlos are in need of Home Economics Building. These facilities are essential for the development of the students as they host classes that are the basics of livelihood, hygiene and running a household. They also serve as workshops that teach children fundamental lessons in nutrition, crafting, agriculture, commerce and financial management.

They are important facilities that will help society progress from its core, which are the individual families.

## B. General Objectives

The objective of the construction program by the DepEd is to provide the needed facilities for these schools. These classrooms shall hold a multitude of classes relating to household management. These subjects are not limited to cookery, tailoring, wood crafting, gardening, and marketing.

These buildings may also be used as temporary accommodations for some of the faculty and staff especially in the very distant or hard to access schools.

## C. The Bidder

The bidder/contractor must have undertaken at least a One-storey building in the last 5 years.

## D. The Requirements

### 1. Scope of Works

#### General Conditions

- The project is a construction of 1-Storey Home Economics Building.
- All plans and specifications shall be provided by the end-user.
- The work to be executed in this project shall include Mobilization, Concrete and Masonry Works, Roof Framing and Roofing works, Ceiling works, Tile works, Painting works, Doors and Windows, Plumbing works, Electrical works and Demobilization.
- The contractor shall make sure that the existing adjacent structures shall be protected from damage during construction.
- All workmanship and materials used in the project shall be of quality standard and in accordance with the technical specifications, plans, and other requirements.
- All workmanship, materials and fixtures shall be subjected for inspection by the Engineer /Project in charged that may check and ask for samples of materials to be used for the said project.



- Construction safety and health protocols should be observed at all times by the contractor during the duration of the project.
- Clean up of the construction site after the project shall be the responsibility of the contractor

**Material Specifications**

**CONCRETE AND MASONRY WORKS**

Portland Cement  
 Washed Sand  
 Crushed Gravel  
 CHB 4: x 8" x 16"  
 10mm DRSB  
 12mm DRSB  
 RL 2"x2"x8"  
 RL 2"x3"x10"  
 Ordinary Plywood 1/2"  
 GI tie Wire  
 CW Nails 4"  
 Concrete Nails 3"

**ROOFING FRAMING AND ROOFING WORKS**

Angle bar 1.5"x1.5"x 3/16"  
 Angle bar 1"x1"x 3/16"  
 Angle bar 1"x1"x 1/8"  
 C-Purlins 2" x 6" x No. 16  
 C-Purlins 2" x 3" x No. 16  
 10mm DRSB  
 12mm DRSB  
 Welding Electrode  
 Rib Type Roofing 0.4mm x 1.0m x L.S.  
 Ridge Roll 0.40mm x 18" x 2.44m  
 Metal Fascia 0.40mm x 18" x 2.44m  
 Flashing Fascia Cover 0.40mm x 18" x 2.44m  
 Metal Fascia 0.40mm x 24" x 2.44m  
 Teks Screw 2"  
 Blind Revits 5/32"

**CEILING WORKS**

Fiber Cement Board 4' x 8' x 3/16"  
 Double Furring  
 Carrying Channel  
 Wall Angle  
 W-Clip  
 Job Screw  
 Hardiflex Screw  
 Diamond Cutting Disc  
 Ceiling Vent

### TILE WORKS

60 x 60cm Gloss Floor  
60 x 60 cm Gloss Kitchen and  
Backsplash Tiles  
30 x 30cm Non Skid Floor Tiles  
30 x 30cm Gloss Wall tiles  
Portland Cement  
Washed Sand  
Tile Adhesive

### PAINTING WORKS

Acrylic Primer  
Acrylic Reducer  
Semi Gloss Latex  
Flat Latex  
Body Filler  
Marine Epoxy  
QDE  
Red Oxide Metal Primer  
Paint Thinner  
Tinting Color latex  
Tinting Color oil  
Skimcoat  
Patching Compound  
Paint Roller Assorted  
Paint Brush Assorted  
Sand Paper Assorted

### DOORS AND WINDOWS

Panel Door 1.00 x 2.10m  
Panel Door 0.90 x 2.10m  
Panel Door 0.80 x 2.10m  
Door Jamb 2" x 6"  
PVC Door 0.60m x 2.10m  
Door Lock set  
Loose Pin Hinges 3.5"x 3.5"  
Jalouplus Windows  
Glass Blocks  
Square Bar 10mm  
Welding Electrode

### PLUMBING WORKS

Back Tank type Water Closet with  
complete accessories  
Lavatory Ceramic with complete accessories  
Telephone Shower with faucet

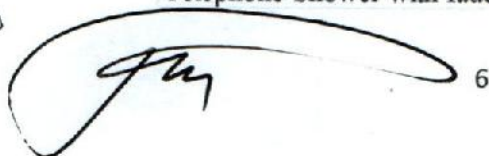

Urinal Ceramic with complete Accessories  
Kitchen Sink with Complete Accessories  
Goose Neck Faucet, High quality  
Floor drain 2"  
pvc tee 4x4  
pvc elbow 4x90  
pvc elbow 4 x 45  
pvc solvent 200cc  
pvc pipe 4" sc 900  
pvc pipe 2" sc 900  
pvc blue 1/2"  
pvc blue 3/4"  
pvc elbow 1/2 x 90 threaded blue  
pvc elbow 1/2 x 90 plain blue  
pvc tee 1/2 threaded blue  
pvc tee 1/2 plain blue  
pvc mail adaptor blue  
pvc female adaptor blue  
teflon tape

#### **ELECTRICAL WORKS**

THHN Stranded wire No.8 (100m/roll)  
THHN Stranded wire No.10 (150m/roll)  
THHN Stranded wire No.12 (150m/roll)  
THHN Stranded wire No.14 (150m/roll)  
Panel Board with CB (1-60A, 2-15A, 2-20A  
4-30A) with complete accessories  
Pinlight Housing 4"  
12W LED Bulb  
Flexible hose 1" (100m/roll)  
Electrical Moulding 1"  
3 gang convenience outlet flush mount type  
Aircon Outlet  
2 gang switch flush mount type  
Electrical Conduit 20mm dia. x 3m  
Electrical Conduit 25mm dia. x 3m  
Electrical Conduit 50mm dia. x 3m  
Utility box 2"x4"  
Junction box Octagon  
Electrical Tape Big

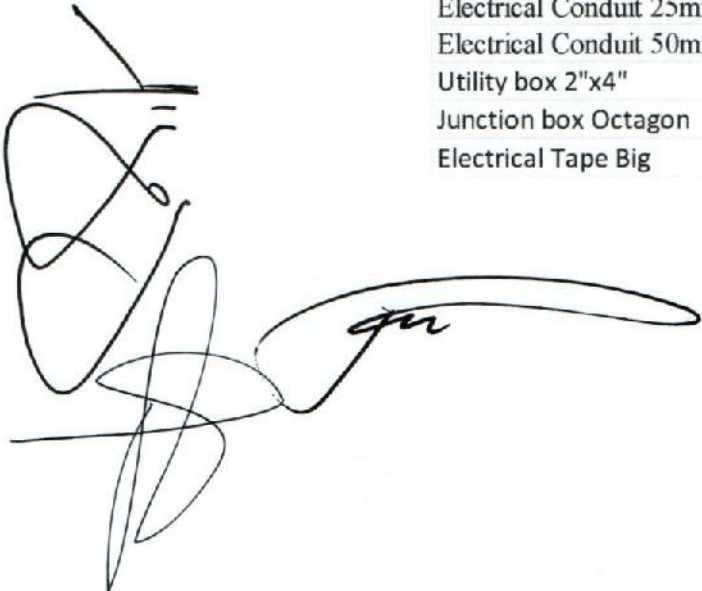



**E. Delivery / Completion**

Delivery/completion shall be within 120 Calendar days.

**F. Man Power Requirement**

Manpower for the project shall be at least of the following:

- a. One Civil Engineer
- b. Skilled Laborers
- c. Manual Laborers

**G. Warranty**

Warranty shall be for a period of one year from the turn-over of the completed project.

**H. Payment Scheme**

The city has allocated a budget of Three Million, Three Hundred sixty-two thousand, Two hundred Pesos (3,362,200.00Php) for the project. The winning bidder shall be paid in accordance with **R.A. 9184** and other relevant laws.

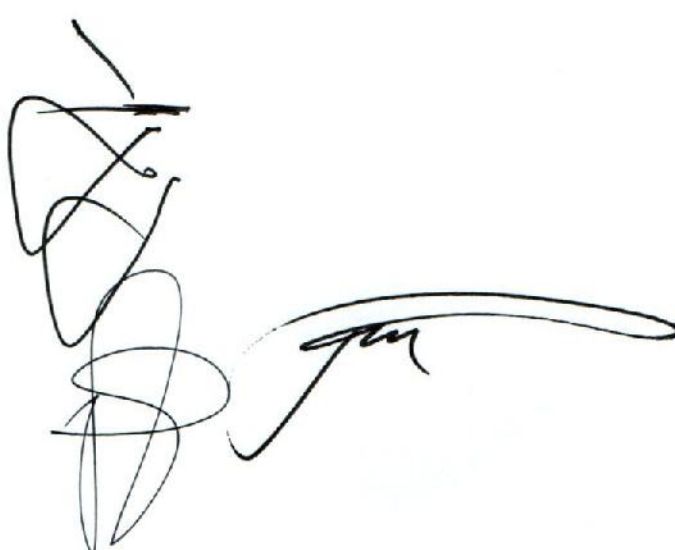
A large, stylized handwritten signature in black ink, consisting of several loops and a long horizontal stroke, is located at the bottom left of the page.





# P E R S P E C T I V E S

From the office of : <b>CED</b> Drafted by TRISHA C. TREJEROS Draftsman - 1	Project Title <b>CONSTRUCTION OF HOME ECONOMICS BUILDING AT          BAIRAN ELEMENTARY SCHOOL, BRGY. BULUANGAN</b> Location : Brgy. Buluangan, San Carlos city, Negros Occidental	Prepared : <b>JOHTEUR C. VIRTUCIO</b> Engineer - I	Checked  <b>MELVIN A. BRIONES</b> Engineer - III	Recommended for Approval :  <b>ALEXANDER NEMENZO</b> CCEP-I (City Engineer)	Approved as to Plans and Specifications :  <b>HON. RENATO Y. GUSTILO</b> City Mayor	Sheet No : <b>1</b>
---	---	--	---	--	--	------------------------



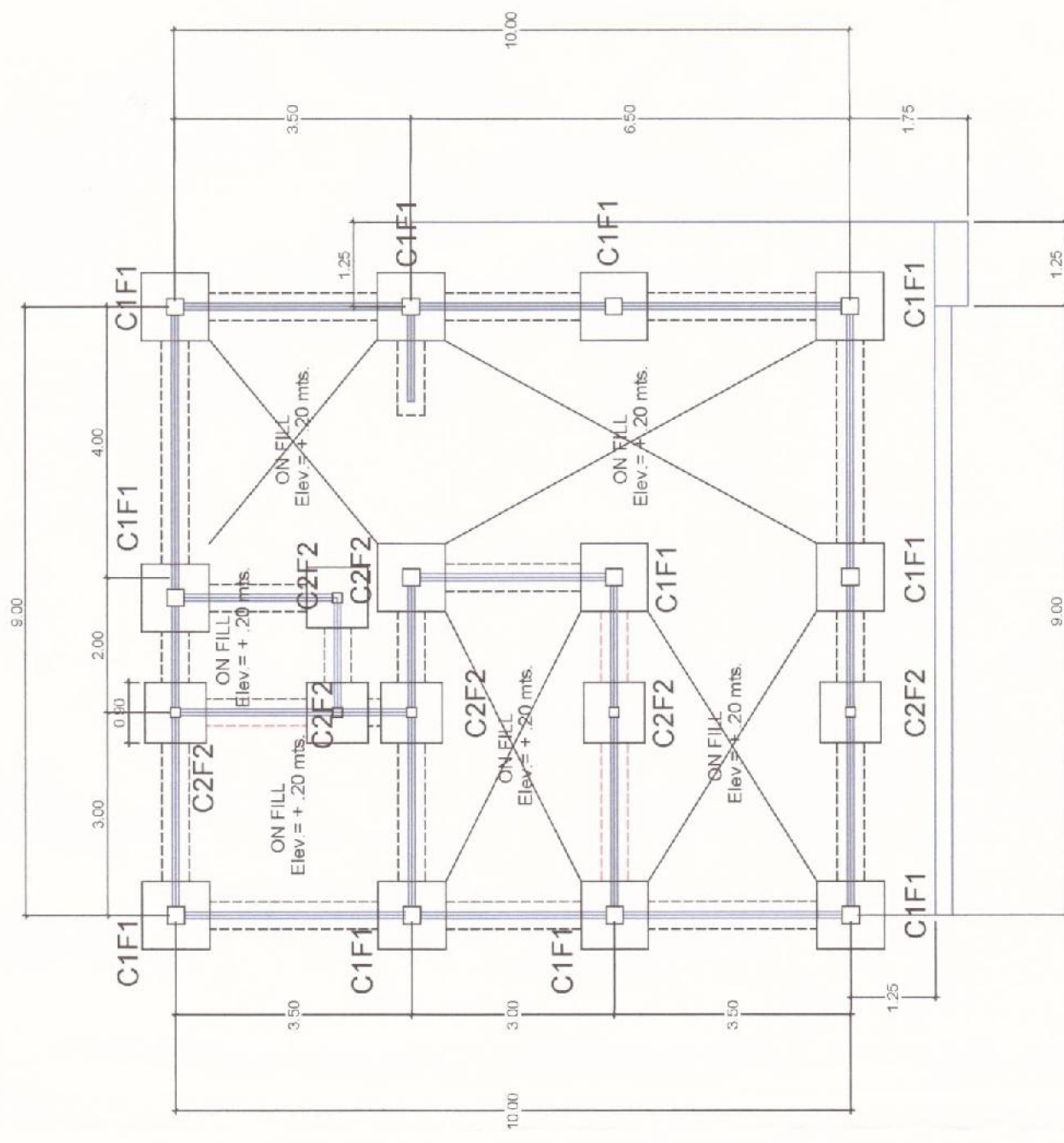
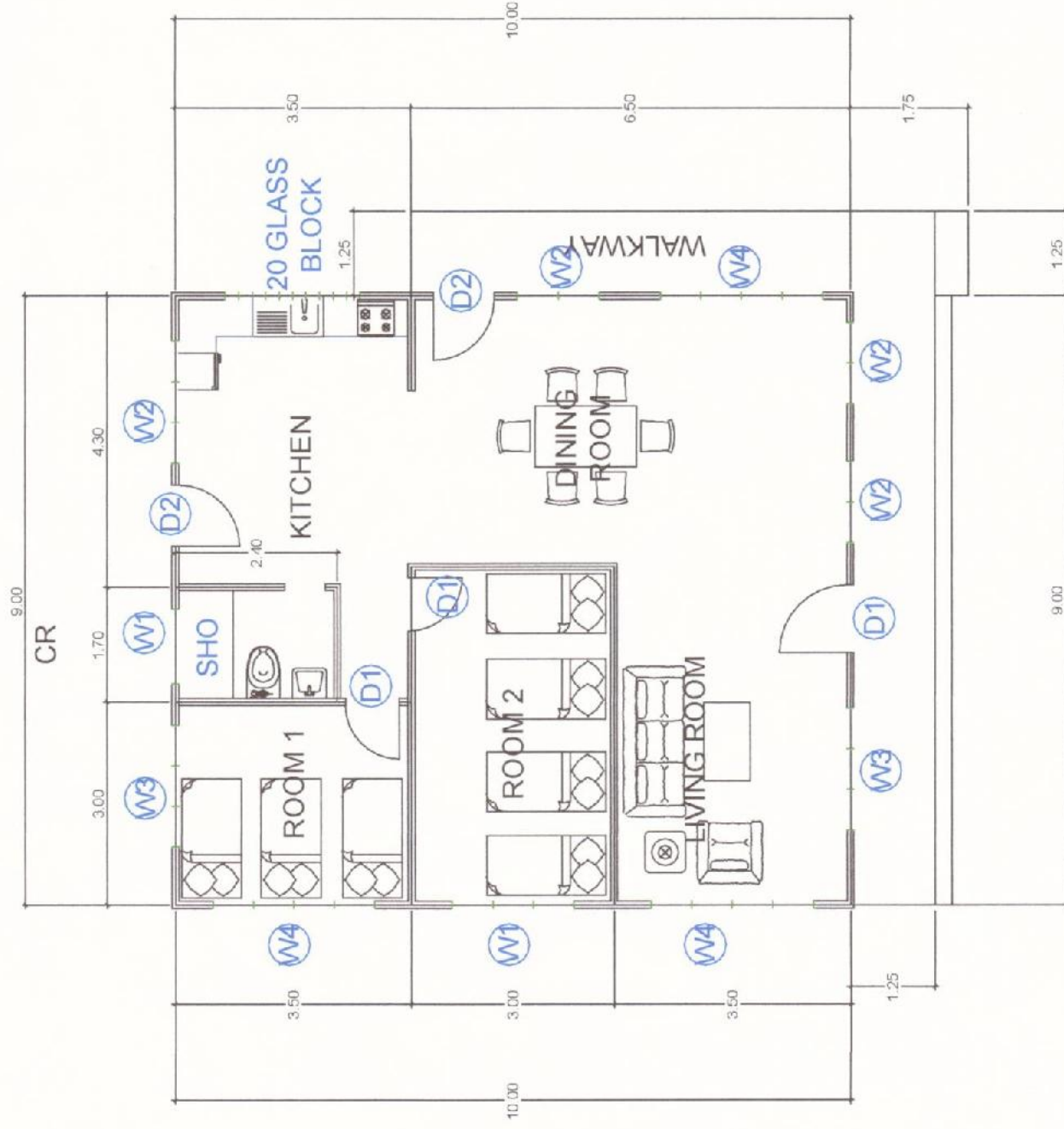

**FLOOR LAYOUT**  
SCALE 1:100

**FOUNDATION LAYOUT**  
SCALE 1:100

From the office of: <b>CED</b> Drafted by: TRISHA C. TREJEROS Draftsman - 1	Project Title: <b>CONSTRUCTION OF HOME ECONOMICS BUILDING AT BAIKAN ELEMENTARY SCHOOL, BRGY. BULUANGAN</b> Location: Brgy. Buluangan, San Carlos city, Negros Occidental	Prepared:  <b>JOH LEURIC VIRTUCIO</b> Engineer - I	Checked:  <b>MELVIN A. BRIONES</b> Engineer - III	Recommended for Approval:  <b>REXTER E. NEMENZO</b> CO-EDH I (City Engineer)	Approved as to Plans and Specifications:  <b>HON. RENATO Y. GUSTILO</b> City Mayor	Sheet No: <b>2</b>
---	--	---	--	---	---	-----------------------



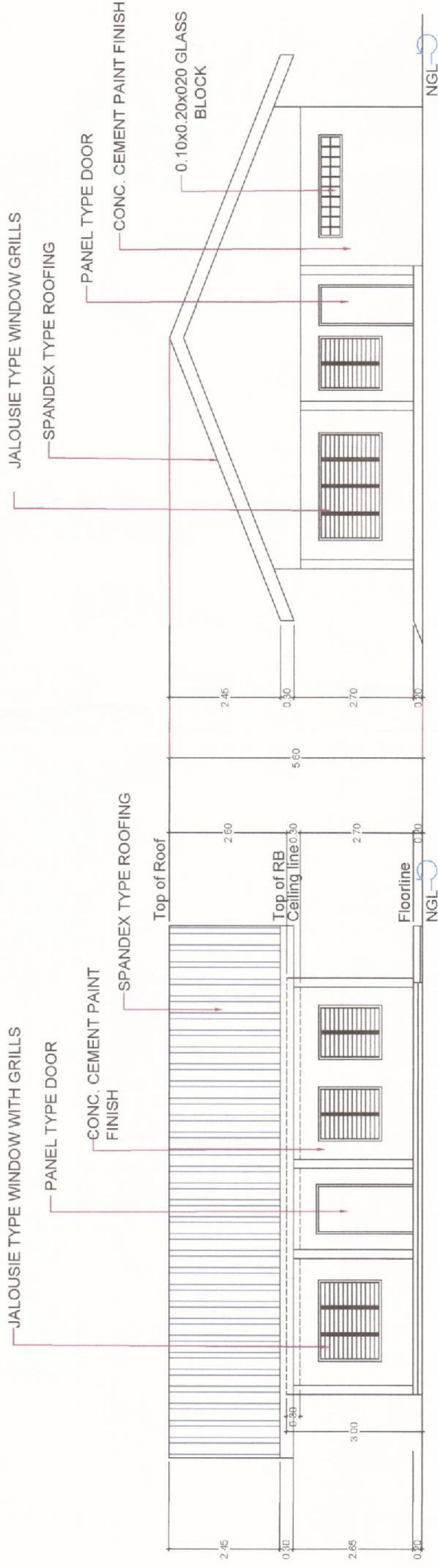

**FRONT ELEVATION**  
SCALE: 1:100

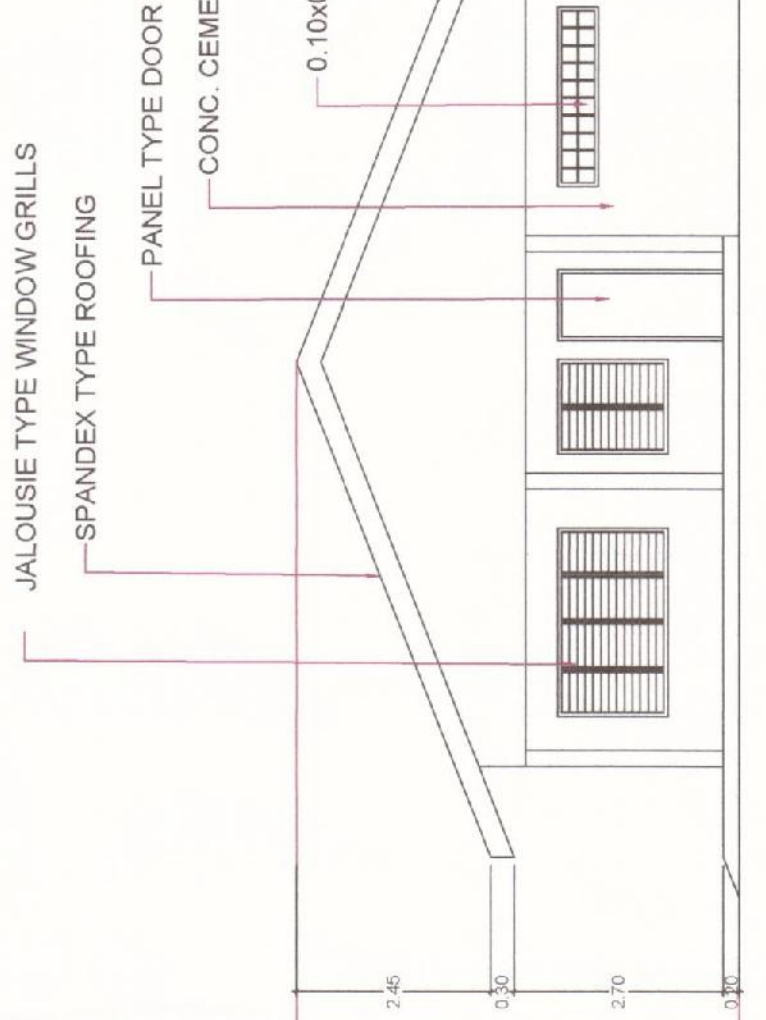

**RIGHT ELEVATION**  
SCALE: 1:100

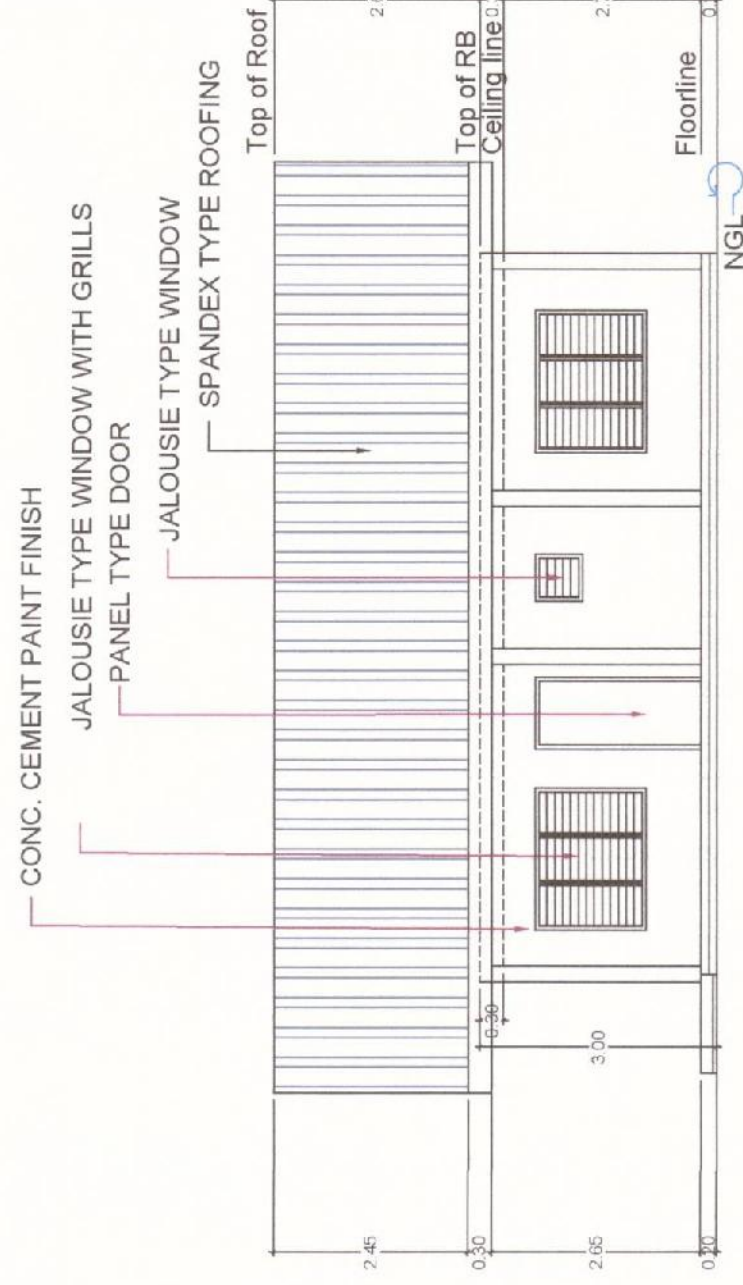

**REAR ELEVATION**  
SCALE: 1:100

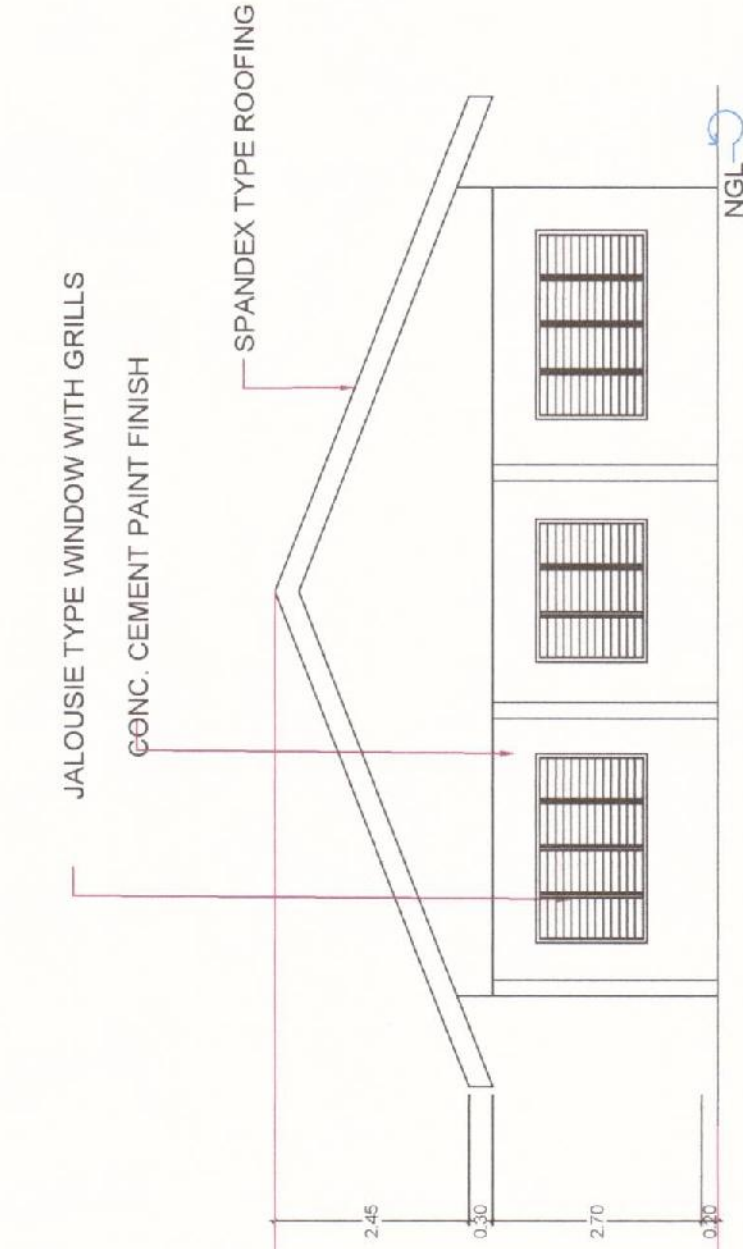

**LEFT ELEVATION**  
SCALE: 1:100

From the office of: <b>CED</b> TRISHA C. TRELEROS Draftsman - 1	Project Title: <b>CONSTRUCTION OF HOME ECONOMICS BUILDING AT BAIRAN ELEMENTARY SCHOOL, BRGY. BULUANGAN</b> Location: Brgy. Buluangan, San Carlos city, Negros Occidental	Prepared: <b>JORLEUP C. VIRTUCIO</b> Engineer - I	Checked: <b>MELVIN A. BERNIERES</b> Engineer - III	Recommended for Approval: <b>REXTER E. NEMENZO</b> CgDH I (City Engineer)	Approved as to Plans and Specifications: <b>HEN-RENATO Y. GUSTILO</b> City Mayor	Sheet No: <b>3</b>
--	--	---	--	---	--	-----------------------



**F1C1**

14 - 16mm x 900mm  
Laid bothways spaced  
@150mm.oc

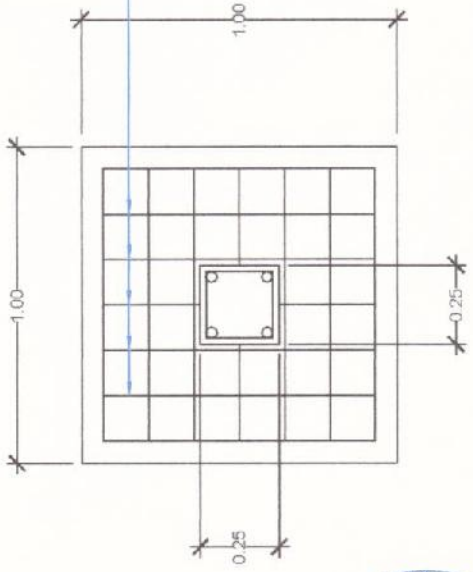

**F2C2**

14 - 16mm x 810mm  
Laid bothways spaced  
@135mm.oc

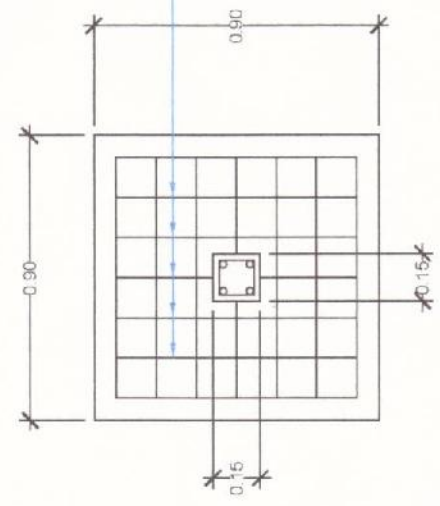

**COLUMN DETAILS**  
SCALE: 1:25

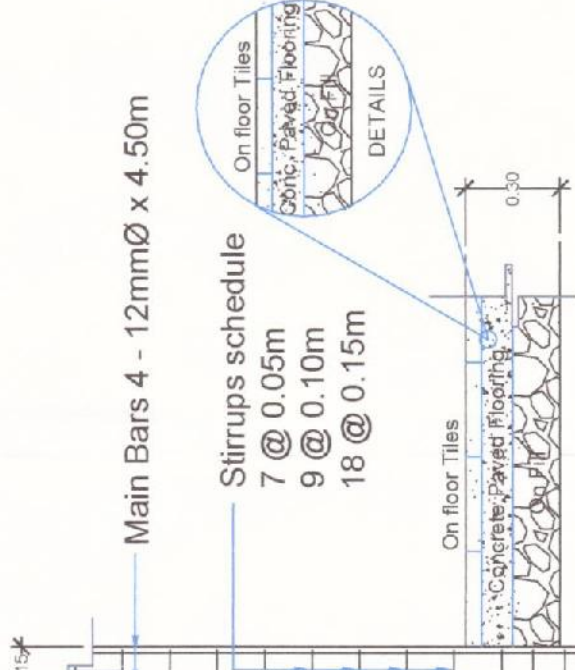
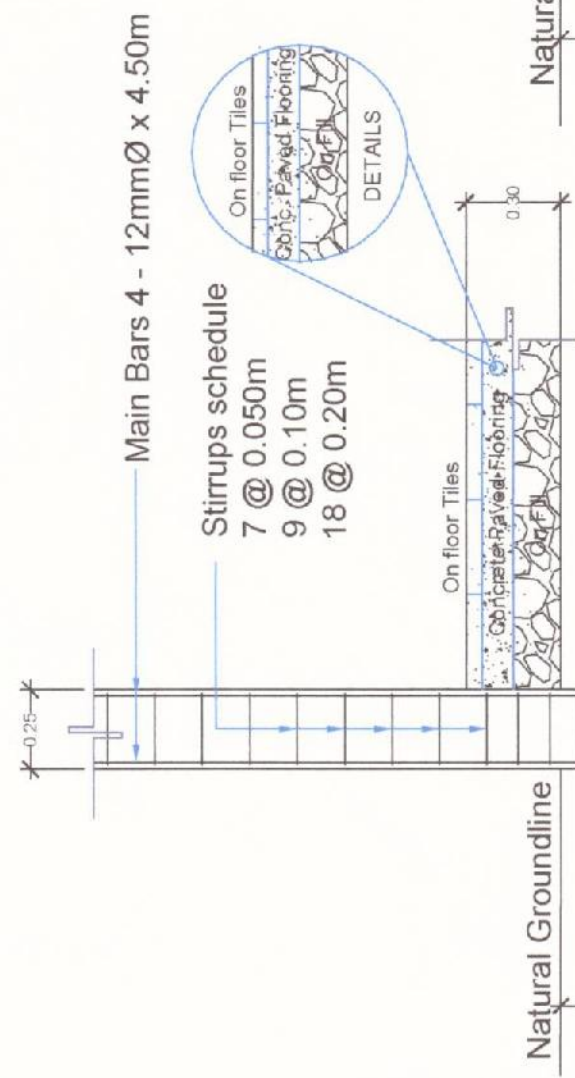

**C2F2**

Main Bars 4 - 12mmØ x 4.50m

Stirrups schedule  
7 @ 0.05m  
9 @ 0.10m  
18 @ 0.15m

14 - 16mm x 810mm  
Laid bothways spaced @135mm.oc  
BOTTOM BARS @ 125mm

**C1F1**

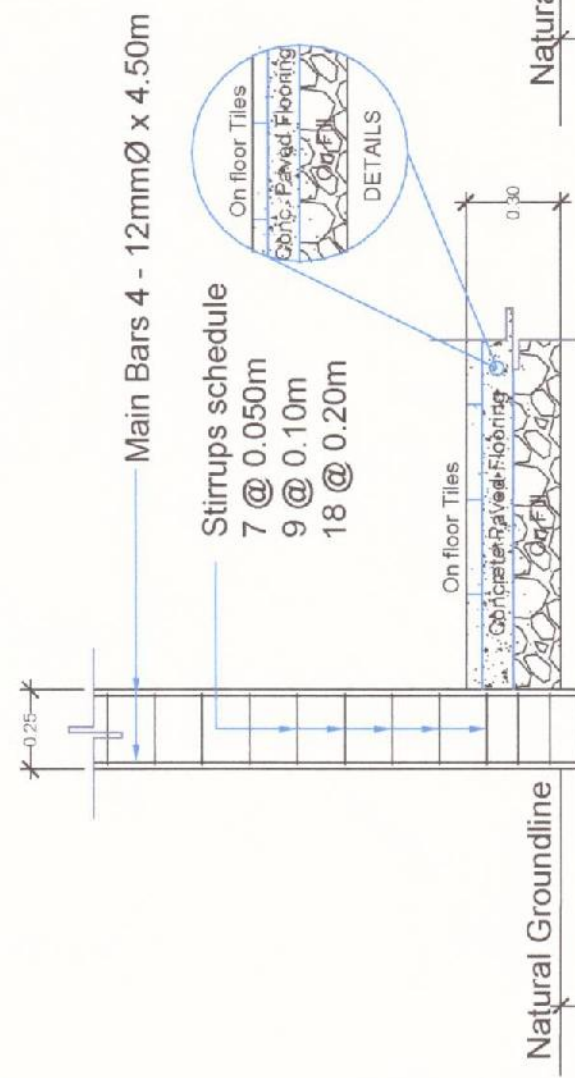

Main Bars 4 - 12mmØ x 4.50m

Stirrups schedule  
7 @ 0.050m  
9 @ 0.10m  
18 @ 0.20m

14 - 16mm x 810mm  
Laid bothways spaced @135mm.oc  
Bottom Bars @ 125mm

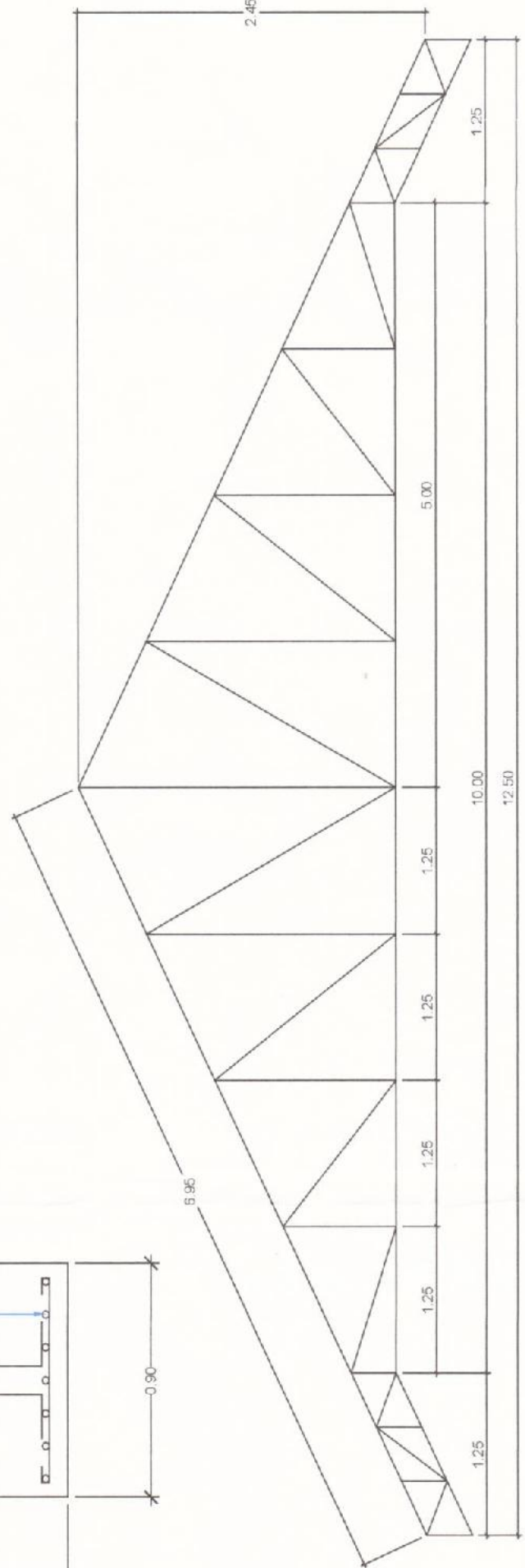

**TRUSS DETAILS**  
SCALE: 1:50

- TOP CHORD LENGTH = 6.95 m ( Use single Angle Bar 5mm x 50mm x 50mm x 6.0 m )
- KING POST = 2.45m ( Use single Angle Bar 5mm x 50mm x 50mm x 6.0 m )
- WEB MEMBERS = Use single Angle Bar @ 5mm x 50mm x 50mm x 6.0 m
- BOTTOM CHORD = 10.50m ( Use single Angle Bar 5mm x 62mm x 62mm x 6.0 m )
- TRUSSES spaced @ 3.00M.O.C
- FASCIA FRAMING ( see details )

**WALL FOOTING DETAILS**  
SCALE: 1:25

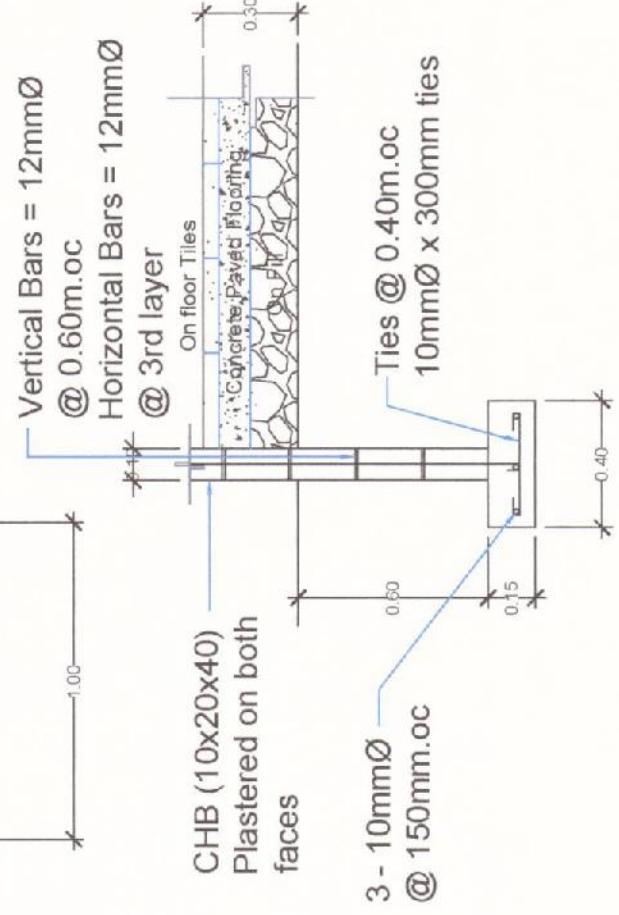

CHB (10x20x40)  
Plastered on both  
faces

3 - 10mmØ  
@ 150mm.oc

Vertical Bars = 12mmØ  
@ 0.60m.oc

Horizontal Bars = 12mmØ  
@ 3rd layer

Ties @ 0.40m.oc  
10mmØ x 300mm ties

From the office of: <b>CED</b> TRISHA C. TREJEROS Draftsman - 1	Project Title: <b>CONSTRUCTION OF HOME ECONOMICS BUILDING AT BAIRAN ELEMENTARY SCHOOL, BRGY. BULUANGAN</b> Location: Brgy. Buluungan, San Carlos city, Negros Occidental	Prepared by: <b>JORTEUR C. VIRTUCIO</b> Engineer - I	Checked by: <b>MELVIN A. BRIONES</b> Engineer - III	Recommended for Approval: <b>REXTER E. NEMENZO</b> CDDH I (City Engineer)	Approved as to Plans and Specifications: <b>HON. RENATO T. GUSTILO</b> City Mayor	Sheet No.: <b>4</b>
--	--	--	---	---	---	------------------------



C - PURLINS 1.5 mm x 50 mm x 75 mm spaced @ 0.70 m.o.c

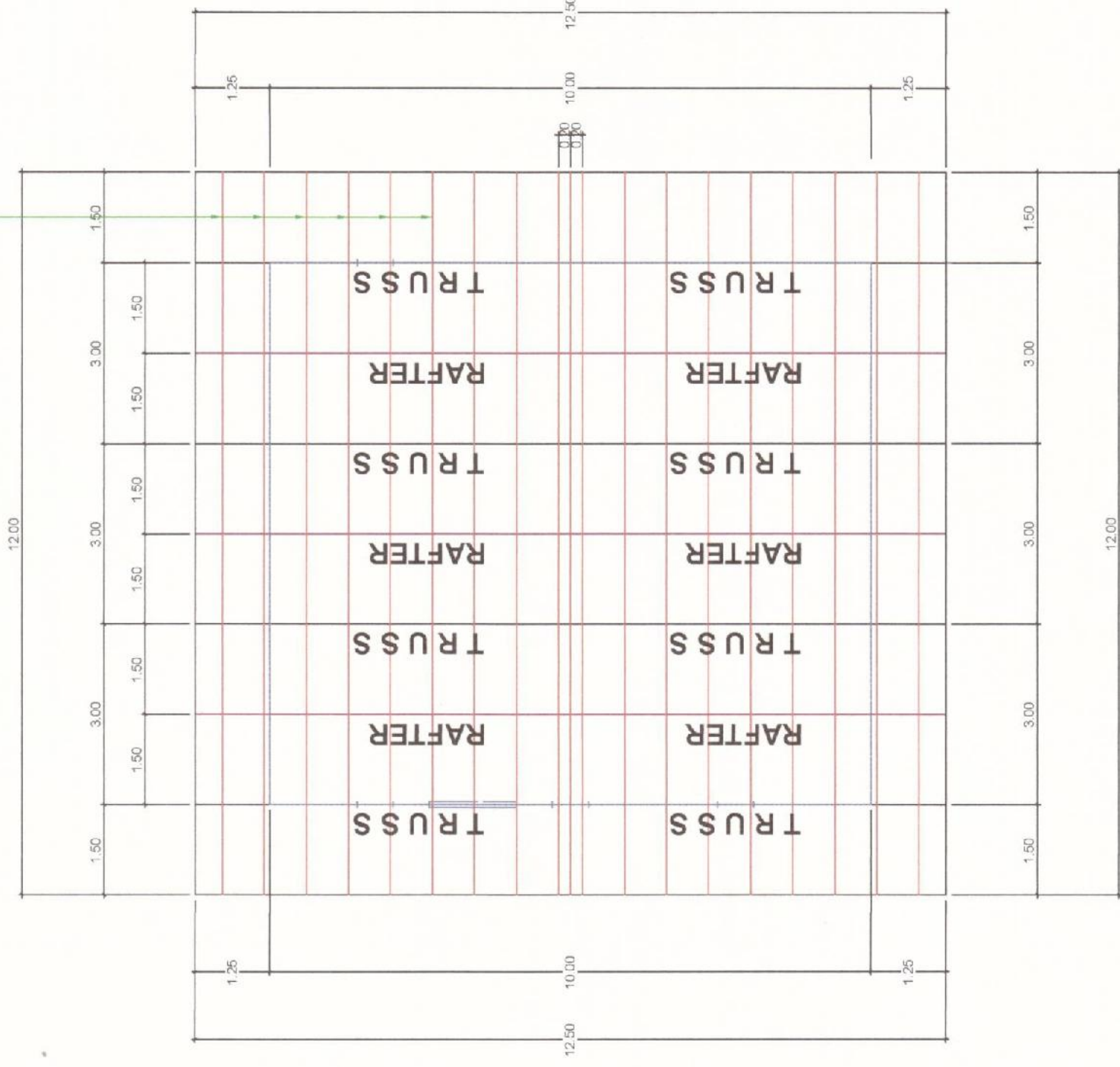

ROOF FRAMING LAYOUT  
SCALE 1:100

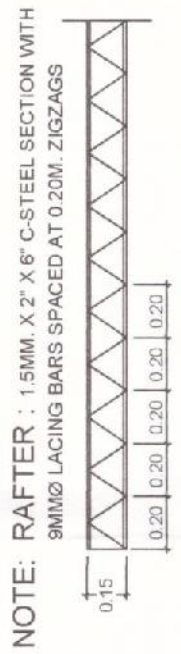

RAFTER 1 DETAIL

NOTE: RAFTER : 1.5MM X 2" X 6" C-STEEL SECTION WITH 9MMØ LACING BARS SPACED AT 0.20M. ZIGZAGS

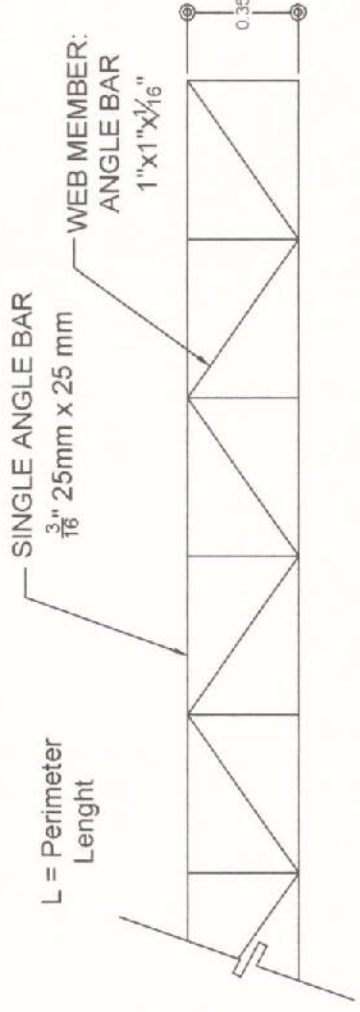

FASCIA FRAME DETAILS  
SCALE: 1:25

4- 16 mm.Ø DRSB Main Bars with 10 mm Ø Stirrups spaced at 0.20 moc.

4- 16 mm.Ø DRSB Main Bars with 10 mm Ø Stirrups spaced at 0.20 moc.

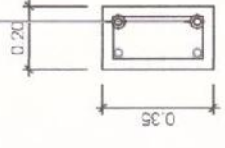

CONCRETE ROOF BEAM DETAILS  
SCALE: 1: 25 MTS

SCHEDULE OF DOORS AND WINDOWS

DOOR / WINDOW NO.	QUANTITY		DIMENSION		REMARKS
	UNITS	SETS	WIDTH	HEIGHT	
D1	3	1	1.00	2.10	PANEL TYPE DOOR
D2	2	1	0.90	2.10	PANEL TYPE DOOR
D3	1	1	0.60	2.10	PVC TOILET BATH DOOR
W1	1	1	0.40	0.50	GLASS JALOUSIE WINDOW
W2	3	2	1.30	1.35	GLASS JALOUSIE WINDOW
W3	4	3	1.95	1.35	GLASS JALOUSIE WINDOW
W4	3	4	2.60	1.35	GLASS JALOUSIE WINDOW

From the office of:  
**CED**  
Drafted by TRISHA C. TREJEROS  
Draftsman - 1

Project Title:  
CONSTRUCTION OF HOME ECONOMICS BUILDING AT  
BAIRAN ELEMENTARY SCHOOL, BRGY. BULUANGAN  
Location: Brgy. Buluangan, San Carlos city, Negros Occidental

Prepared:  
JOH LEUR Q. VIRTUCIO  
Engineer - I

Checked:  
MELVIN A. BRIONES  
Engineer - III

Recommended for Approval:  
REXTER E. NEMENZO  
CGDH I (City Engineer)

Approved as to Plans and Specifications:  
HON. RENATO Y. GUSTILO  
City Mayor

Sheet No.:



# POWER PANEL SINGLE LINE DIAGRAM

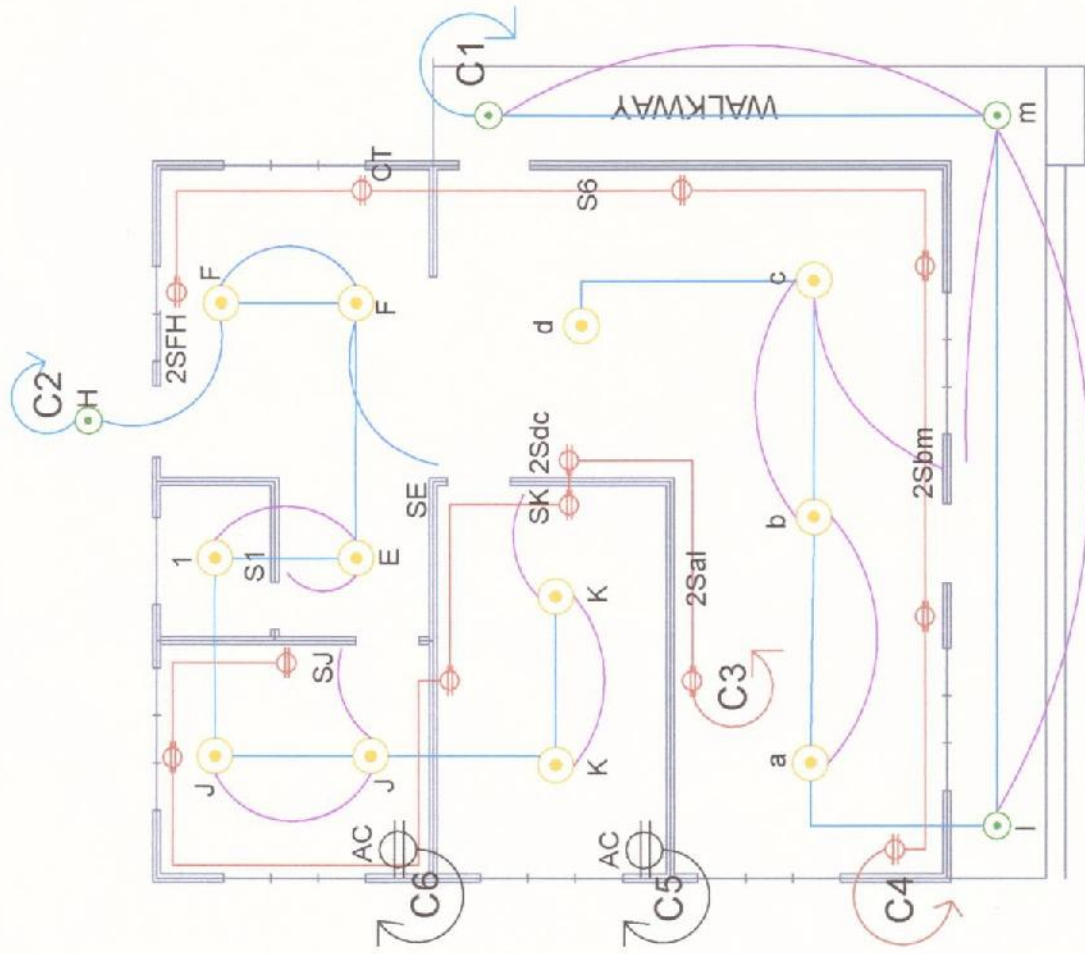
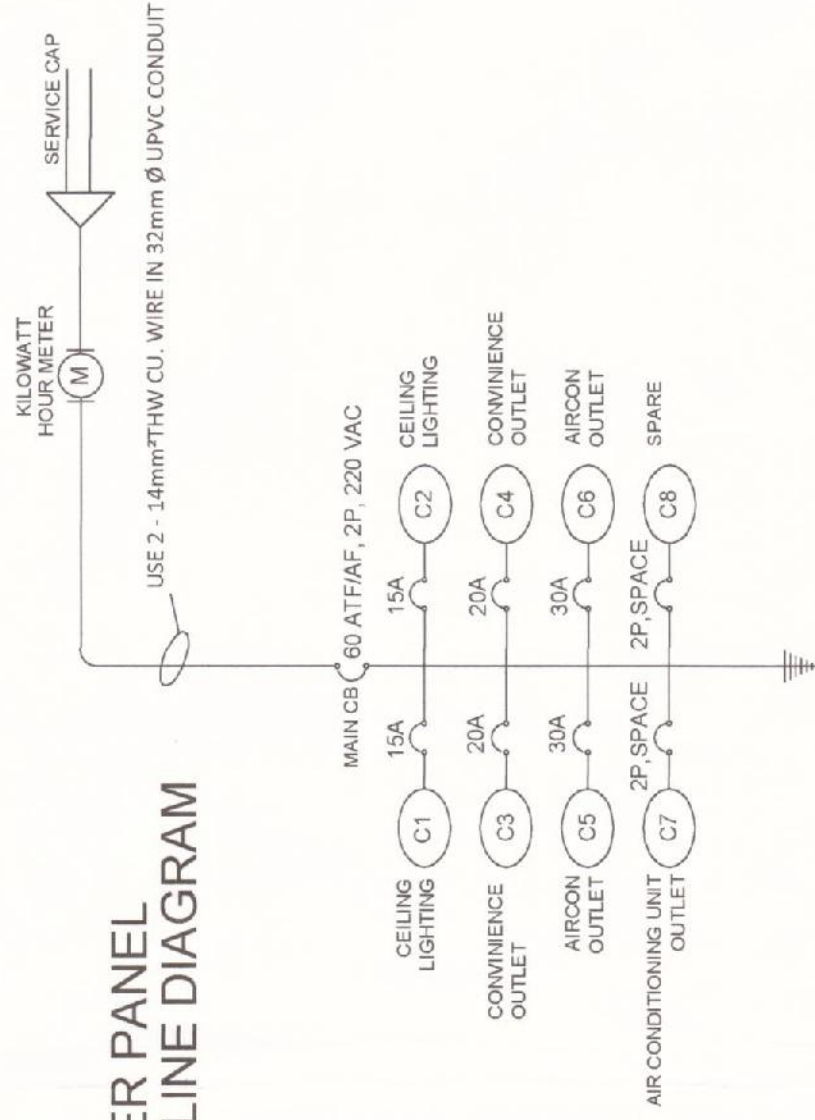

## ELECTRICAL LAYOUT

SCALE: 1:100

- 7W, 220 VAC, E27 LED (COOL WHITE) IN 5"Ø WHITE METAL RIM WITH E27 SOCKET & ALUMINUM REFLECTOR
- 15 W, 220 VAC, 527 LED (DAYLIGHTY) IN 5"Ø WHITE METAL RIM W/ E27 SOCKET & ALUMINUM PROTECTOR
- 10 A, 220 VAC, FLUSH TYPE DUPLEX CONV. OUTLET
- 10 A, 220 VAC, FLUSH TYPE AIRCON OUTLET

- 10 A, 220 VAC, FLUSH TYPE DUPLEX C.O
- 10 A, 220 VAC FLUSH TYPE SINGLE SHAP SWITCH
- DUPLEX SHAP SWITCH
- CIRCUIT LINE
- PANEL BOARD
- CIRCUIT HOMERUN

CIRCUIT NO.	CEILING LIGHTING OUTLET	CONVENIENCE OUTLET	WT	VAT	VOLTAGE IN VOLTS	AMPS/CKT.	CB RATING	SIZE OF CONDUCTORS
C1	7		69.00	86.25	220 V	0.3920 A	15 AT, 2P	2 - 3.5mm <sup>2</sup> / 1 - 2.0mm <sup>2</sup> THHN UPVC CONDUIT
C2	9		98.00	122.50	220 V	0.5568 A	15 AT, 2P	2 - 3.5mm <sup>2</sup> / 1 - 2.0mm <sup>2</sup> THHN UPVC CONDUIT
C3		6	1728.00	2160.00	220 V	9.8181 A	20 AT, 2P	2 - 3.5mm <sup>2</sup> / 1 - 2.0mm <sup>2</sup> THHN UPVC CONDUIT
C4		6	1728.00	2160.00	220 V	9.8181 A	20 AT, 2P	2 - 3.5mm <sup>2</sup> / 1 - 2.0mm <sup>2</sup> THHN UPVC CONDUIT
C5			2112.00	2640.00	220 V	12.00 A	30 AT, 2P	2 - 5.5mm <sup>2</sup> / 1 - 2.0mm <sup>2</sup> THHN UPVC CONDUIT
C6			1056.00	1320.00	220 V	6.00 A	30 AT, 2P	2 - 5.5mm <sup>2</sup> / 1 - 2.0mm <sup>2</sup> THHN UPVC CONDUIT
C7	SPACE				220 V		2P SPACE	2 - 5.5mm <sup>2</sup> / 1 - 2.0mm <sup>2</sup> THHN UPVC CONDUIT
C8	SPACE				220 V		2P SPACE	2 - 5.5mm <sup>2</sup> / 1 - 2.0mm <sup>2</sup> THHN UPVC CONDUIT
TOTAL CONNECTED LOADS =			7,691.00	8,488.75	220 V	38.58 A		
			38.58 A (1.00 DF)					
			38.58 AMPERES					
			60 AT, 2P					2 - 14mm <sup>2</sup> / 1 - 32mm <sup>2</sup> THHN UPVC CONDUIT

From the office of:

**CED**

Drafted by:  
TRISHA C. TREJEROS  
Draftsman - 1

Project Title:

CONSTRUCTION OF HOME ECONOMICS BUILDING AT  
BAIRAN ELEMENTARY SCHOOL, BRGY. BULUANGAN

Location: Brgy. Buluangan, San Carlos city, Negros Occidental

Prepared:

JOH LEUR/C. VIRTUCIO  
Engineer - I

Checked:

MELVIN A. BRIONES  
Engineer - III

Recommended for Approval:

REYER E. NEMENZO  
CDDH I (City Engineer)

Approved as to Plans and Specifications:

HON. RENATO Y. GUSTILO  
City Mayor

Sheet No:

6



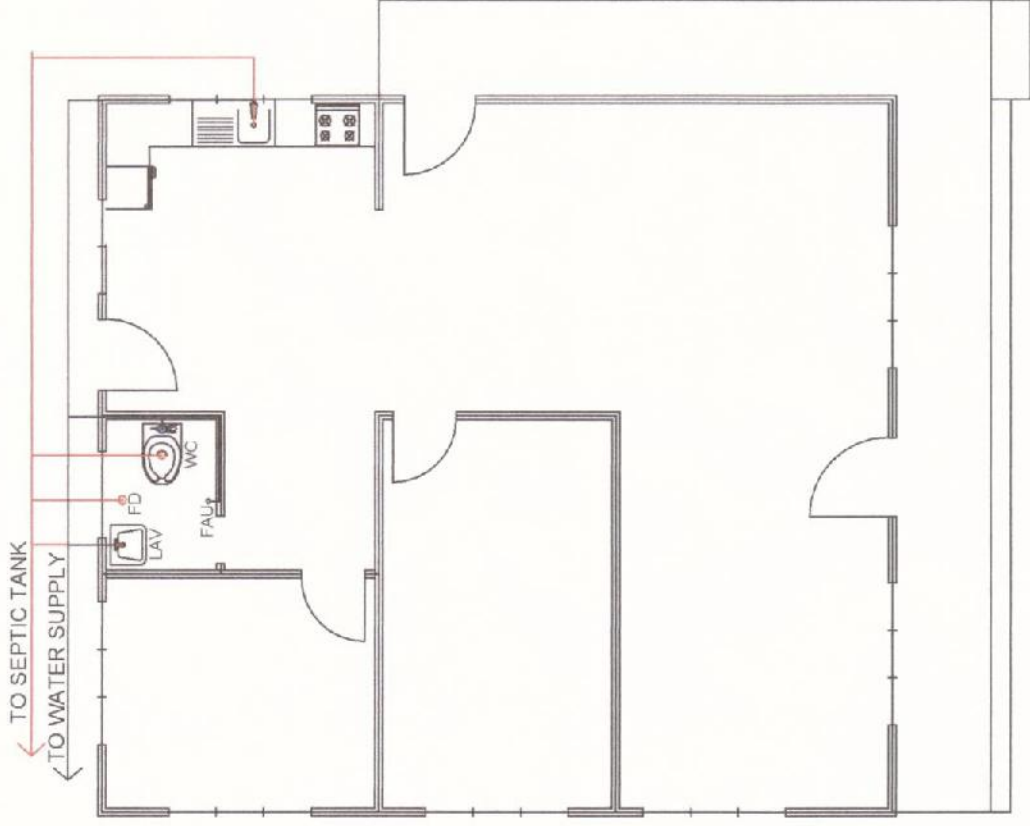

**LEGEND:**

- MH Manhole
- SV Septic Vault
- WC Water Closet
- CO Clean Out
- FAU Faucet
- Waste Pipeline
- Water Supply Line

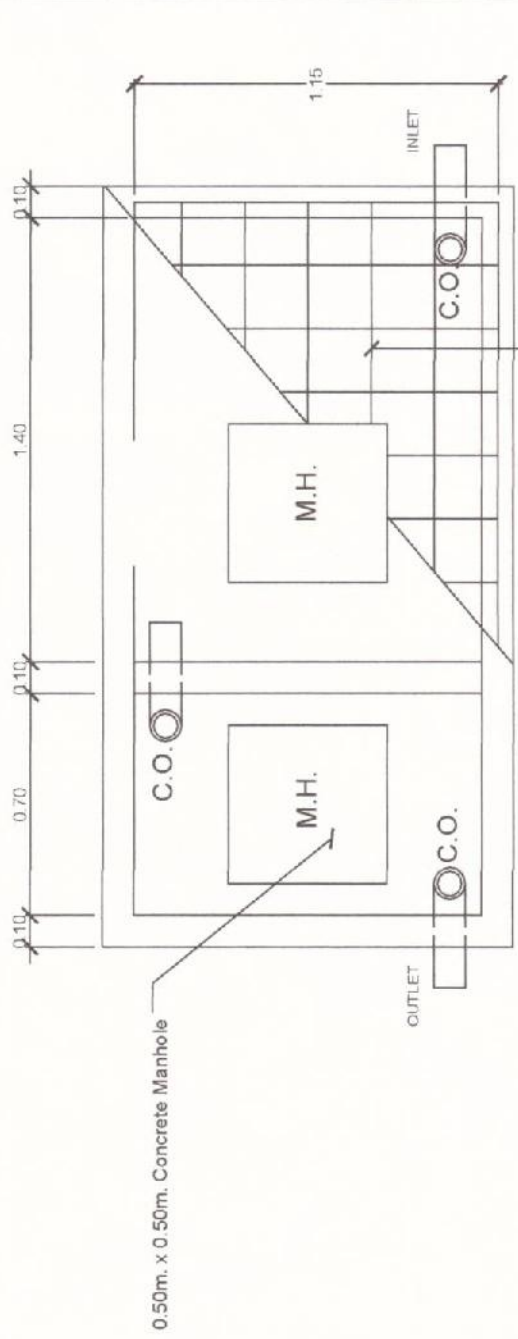
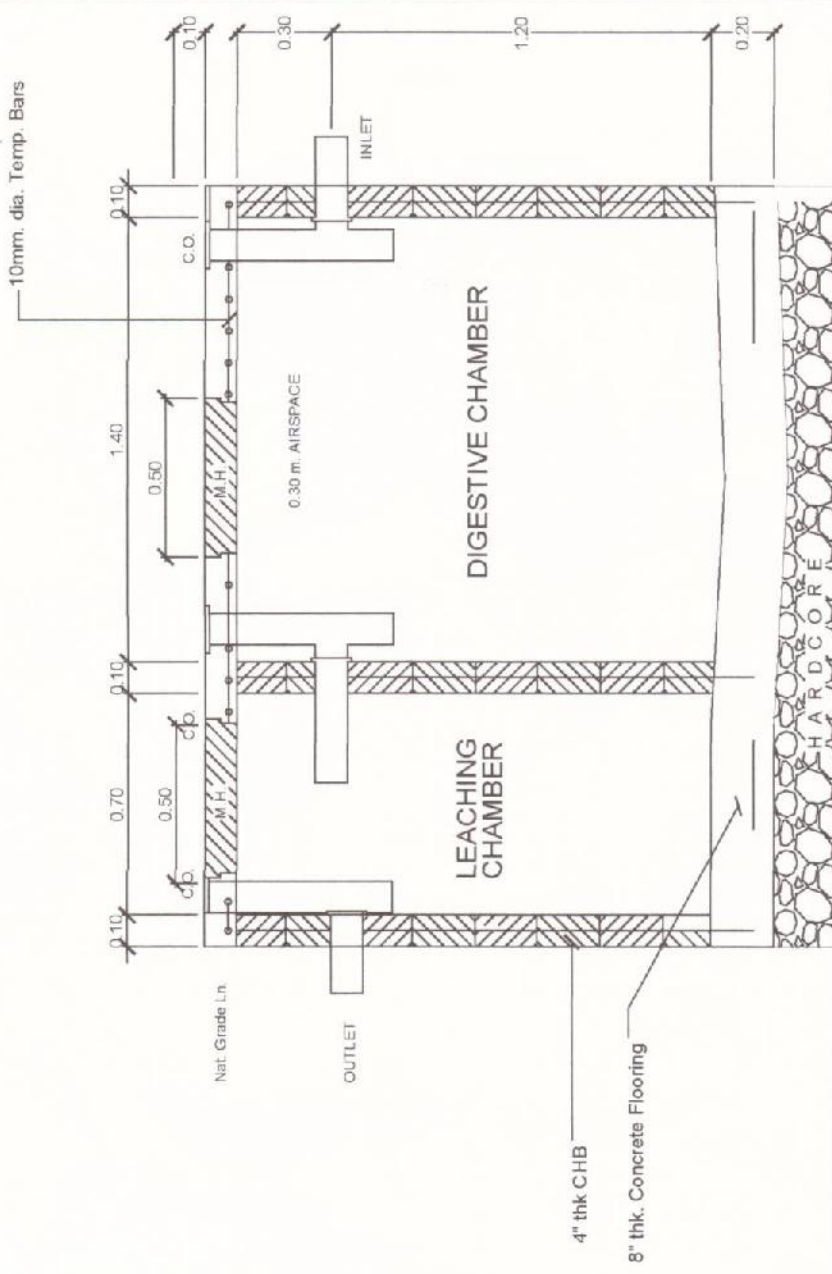

DETAILS OF SEPTIC VAULT  
SCALE: 1:25 MTS

**GENERAL NOTES :**

- SUPPLY LINES SHALL BE OF G.I. PIPE AND WASTE PIPE LINES SHALL BE OF UPVC JOINTS SHALL BE INSTALLED WITH UPVC SOLVENT
- WASTE WATER SHALL BE OF G.I. WITH FITTINGS WHICH SHALL BE OF THREADED JOINTS PROVIDE INDIVIDUAL SHUT-OFF FOR EACH FIXTURE BRANCH
- VENT THRU ROOF (VTR) SHALL BE EXTENDED ONE FOOT ABOVE THE ROOF

PLUMBING LAYOUT  
SCALE: 1:100

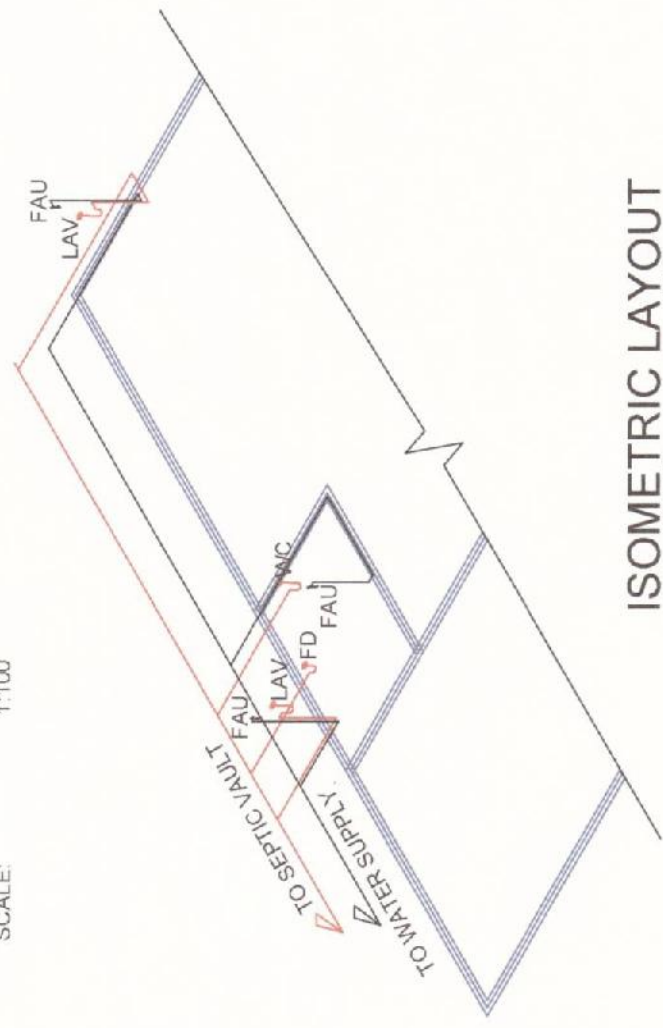

ISOMETRIC LAYOUT  
SCALE: 1:100

OTHER ASPECTS NOT FOUND ON THIS PLAN, PROVISIONS AND REQUIREMENTS OF THE NATIONAL PLUMBING CODE OF THE PHILIPPINES AND REPUBLIC ACT 1378 SHALL PREVAIL

From the office of: <b>CED</b> TRISHA C. TRELEROS Draftsman - 1	Project Title: <b>CONSTRUCTION OF HOME ECONOMICS BUILDING AT BAIKAN ELEMENTARY SCHOOL, BRGY. BULUANGAN</b> Location: Brgy. Buluangan, San Carlos city, Negros Occidental	Prepared: JOHN LEON C. VIRTUCIO Engineer - 1	Checked: MELVIN A. BRIONES Engineer - III	Recommended for Approval: REYNER E. NEMENZO C-CPH I (City Engineer)	Approved as to Plans and Specifications: <i>[Signature]</i> RON. REMATO Y. GUSTILO City Mayor	Sheet No : <b>7</b>
--	--	--	---	---	--	------------------------